



Part No. ALL22104

Roll Cage Kit For Ford Escort

Designed with safety in mind for mini enduro and four cylinder classes. Universal design is built for two or four door 1991-2002 Ford Escort bodies. Kit is constructed of .095" wall 1-3/4" mild Steel tubing and includes a main hoop, halo, windshield posts, front and rear dash bars, three door bars for the left side, and a Z-bar for the right side. Also included are two lengths of 1-3/4" tubing to weld to the factory pinch welds and two lengths of 1-1/2" tubing to connect the two sides, creating a solid foundation for the cage and seat mount.

Part No.	Description	"A"	"B"	"C"	"D"
ALL22104	1991-2002 Ford Escort	53.5"	24.5"	37.5"	40"

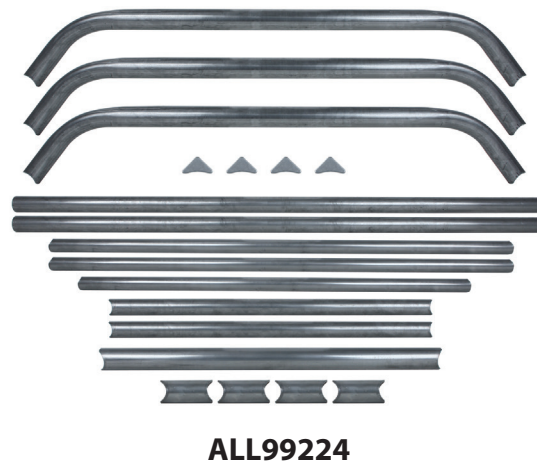
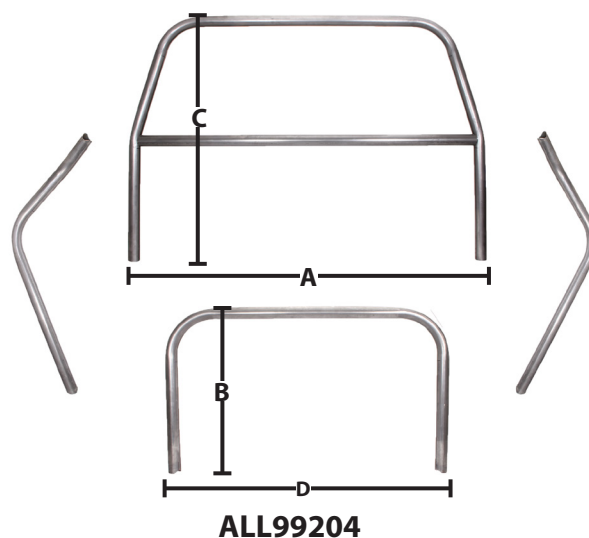

Individual Components:

ALL99204.....Mini Hoop assembly for ALL99204

ALL99224.....Component Box for ALL99204

ALL22113.....Curved Door Bar

ALL22116.....Door Bar Spacer

REV081018

Allstar Performance 8300 Lane Dr., Watervliet, MI 49098
Phone: (269) 463-8000 Fax: (800) 772-2618 www.allstarperformance.com