

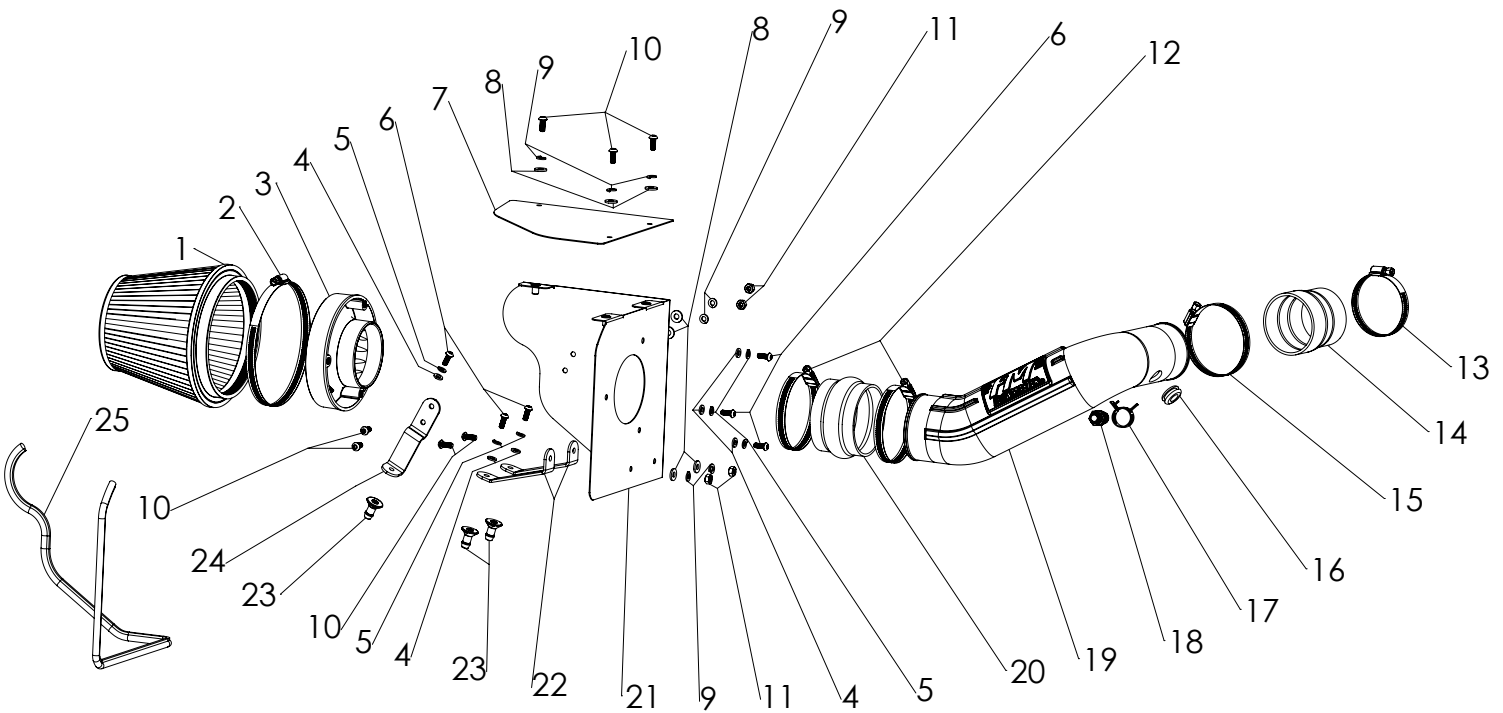

Installation Instructions for: SYSTEM #615142

2007-2011 WRANGLER
3.8L Engine

NOT LEGAL FOR SALE OR USE ON ANY POLLUTION-CONTROLLED MOTOR VEHICLE IN CALIFORNIA OR IN STATES THAT HAVE ADOPTED CALIFORNIA EMISSION PROCEDURES.



ITEM NO.	PART NUMBER	DESCRIPTION	QTY.
1		FILTER, AIR 6.625" HIGH, Ø6" FLANGE	1
2	AF1003	#104 HOSE CLAMP Ø4.125 TO 7"	1
3	AF6001	3.5" AIR FILTER ADAPTER	1
4	HW319	M6 FLAT WASHER SS	6
5	HW318	M6 SPLIT LOCK WASHER SS	6
6	HW244	M6 X 1.0 X 16MM BTNHD SS	6
7	AF3013	12-17 JEEP WRANGLER INTAKE AIRBOX LID	1
8	HW320	1/4" FLAT WASHER SAE SS	7
9	HW322	1/4" SPLIT LOCK WASHER SS	7
10	HW245	1/4"-20 X 5/8" BTNHD SS	7
11	HW115	1/4"-20 NUT SS	4
12	MC350H	#56 HOSE CLAMP Ø3 1/16 TO 4"	2
13	MC250H	#44 HOSE CLAMP Ø2.25" TO 3.25"	1

ITEM NO.	PART NUMBER	DESCRIPTION	QTY.
14	AF4031	3.0"ID X 2.75"ID X 3"L RUBBER COUPLER, STRAIGHT	1
15	MC314H	#52 HOSE CLAMP Ø2 13/16 TO 3 3/4"	1
16	AF4008	GROMMET, RUBBER 1.06"OD X 1/2"ID X 7/16"THK	1
17	MC004P	5/8" HOSE PINCH CLAMP	1
18	AF4032	5/8" HOSE BARB TO 1/4" NPT MALE STRAIGHT	1
19	AF2013	MOLDED INTAKE TUBE, 07-11 JEEP WRANGLER, 3.8L	1
20	AF4019	3.5"ID X 2.5"L RUBBER COUPLER, HUMP	1
21	AF3007	12-17 JEEP WRANGLER INTAKE AIRBOX	1
22	AF5015	11 GA. X 1" BRACKET #2, 15-17 JEEP WRANGLER	2
23	AF7001	M6 X 1.0 BARB INSERT	3
24	AF5014	11GA X 1" BRACKET #1, 12-17 JEEP WRANGLER	1
25	49000061	PUSH ON VINYL AIR BOX TRIM SEAL	1

REVIEW THE INSTRUCTIONS AND VERIFY KIT CONTENTS:

1. Please take a moment to read and understand these instructions before installing your Flowmaster cold air intake kit.



2. Use the parts drawing and list (front page) to verify your kit's contents.

In the unlikely event that any parts are missing, please contact FLOWMASTER Technical Support for replacements.

To simplify assembly and avoid cross-threading fasteners, identify and separate the 1/4-20 screws, item (10) (used with nuts (11) and airbox (21)), and the M6 screws, item (6) (used with barbed pins (23) and filter adapter (3)).

REMOVE FACTORY AIR INTAKE SYSTEM:

NOTES

- We highly recommend that you retain all factory air intake system parts.
- Please refer to vehicle manufacturer's recommendations regarding removal of factory components.
- Disconnecting the negative battery cable erases pre-programmed electronic memories. Write down all memory settings before disconnecting the negative battery cable. Some radios will require an anti-theft code to be entered after the battery is reconnected. The anti-theft code is typically supplied with your owner's manual. In the event your vehicle's anti-theft code cannot be recovered, contact an authorized dealership to obtain your vehicle's anti-theft code.

3. Turn off the vehicle's ignition and disconnect the negative battery cable.



4. Carefully remove intake air temperature sensor electrical connector by pulling the locking tab out until it stops, then depressing the latch and pulling the connector straight off the sensor.



5. Disconnect PCV hose from airbox.

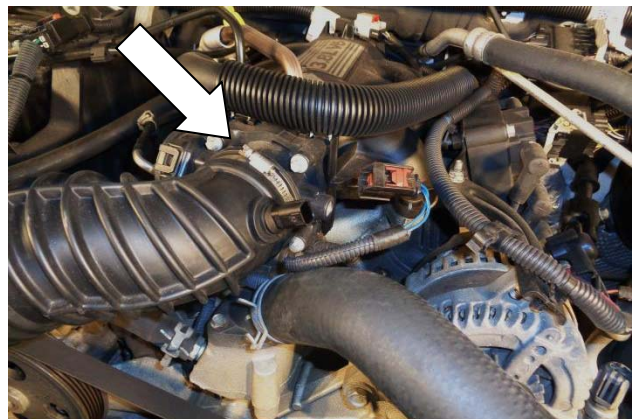

6. Loosen hose clamp securing the air intake duct to the throttle body.



7. The airbox is retained by three barbed pins. Pull the intake duct free of the throttle body, then grasp the airbox and lift the assembled airbox and duct straight up.

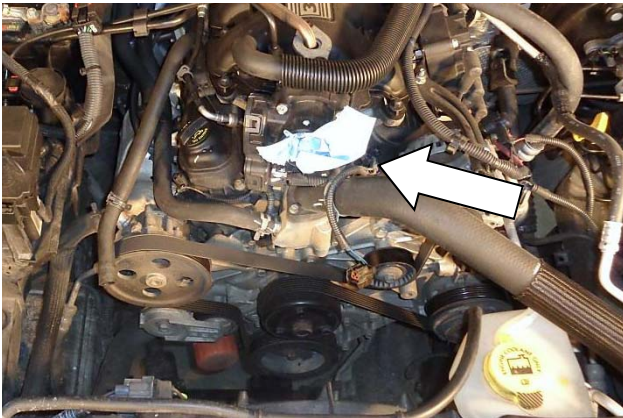

8. Protect the throttle body opening from foreign objects by **temporarily** inserting a clean rag or paper towel in the opening, or securing a plastic bag over the opening with a rubber band. (**To be removed at Step 19.**)

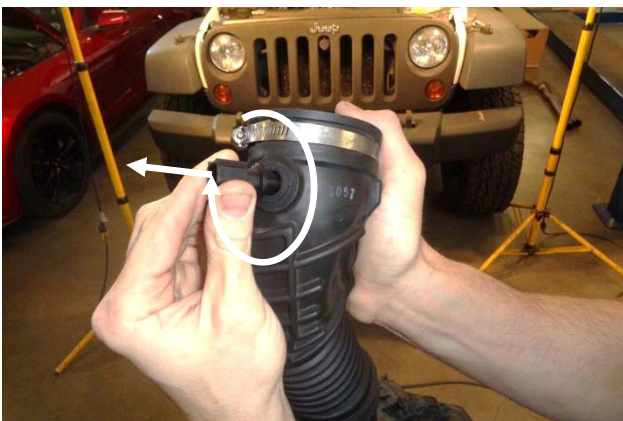

9. The intake air temperature sensor is held in the intake duct by friction. Firmly grasp it and, while pulling it away from the duct, carefully wiggle it around in the duct. **CAUTION: The sensor is delicate!** Handle with care, and store in a safe location until reinstallation.

ASSEMBLE AND INSTALL YOUR FLOWMASTER COLD AIR INTAKE SYSTEM:



10. Attach 1 bracket (24) and 2 brackets (22) to airbox (21) using ¼-20 screws (10) (on the bracket side), and flat washers (8), lock washers (9) and nuts (11) (on the airbox side).



11. Attach the rubber trim seal (25) to the airbox. Starting at either corner, firmly press the seal onto the edge, gradually working around the airbox. At the other corner, trim the seal to fit using metal-cutting shears.



12. Attach barbed pins (23) to brackets using M6 screws (6), lock washers (5), and flat washers (4).

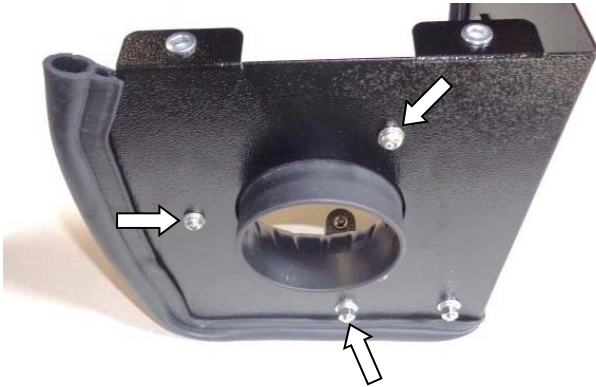

13. Assemble air filter adapter (3) to airbox using M6 screws (6), lock washers (5) and flat washers (4).



14. Set assembled airbox in vehicle, aligning the 3 barbed pins with their rubber grommets in the vehicle. Adjust alignment of brackets (22) if required. Push each pin into its grommet, one at a time. **NOTE:** Moistening the grommets with soapy water will ease insertion.



15. Apply 2 wraps of nylon thread tape to threads of barbed PCV fitting (18), and install fitting in intake tube (19). Install rubber grommet (16) in intake tube.



16. Carefully insert the intake air temperature sensor into the grommet, ensuring that the notch in its base points downstream. **NOTE:** Moistening the grommet with soapy water will ease insertion.



17. Install 2 hose clamps (12) on flex coupler (20), and install coupler on intake end of intake tube. Install hose clamps (15) and (13) on tapered coupler (14), and install coupler on discharge end of tube. Orient clamp screws so as to allow tightening after installation on vehicle.

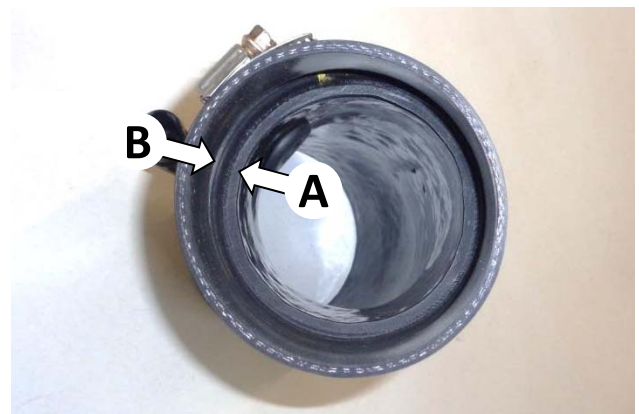

18. To allow proper flexing of the flex coupler during engine torqueing, verify that the end of the intake tube (A) sits even with, or slightly behind, the coupler's transition lip (B).



19. Remove the rag or plastic bag (temporarily installed at Step 8) from the throttle body opening. Install assembled intake tube in vehicle and tighten all hose clamps.

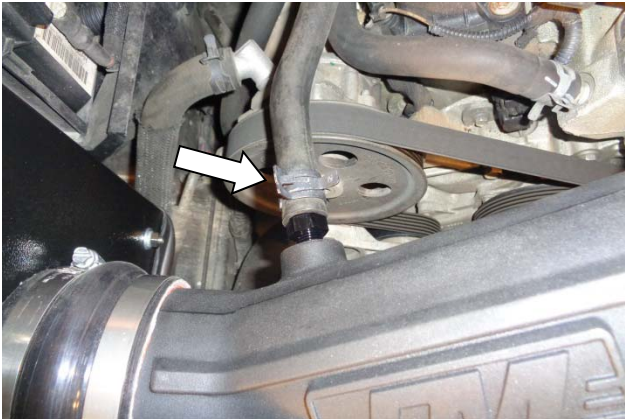

20. Secure PCV hose on barbed fitting with pinch clamp (17).



21. Reinstall the intake air temperature sensor connector and verify the connector is secure.



22. Install clamp (2) on air filter (1), install filter on filter adapter and tighten clamp.



23. Install airbox cover (7) on airbox, using ¼-20 screws (10), lock washers (9), and flat washers (8).



Congratulations, the installation of your FLOWMASTER cold air intake kit is now complete!