



Equipped with AEM® Dryflow™ Filter
No Oil Required!

INSTALLATION INSTRUCTIONS

PART NUMBER: 21-8200

2003	DODGE	Durango	V8-5.9L	SEE *NOTE
2000-2002	DODGE	Durango	V8-5.9L	C.A.R.B. E.O. # D-392-21
2000-1998	DODGE	Durango	V8-5.2L	C.A.R.B. E.O. # D-392-21
1998	DODGE	Dakota	V8-5.9L	C.A.R.B. E.O. # D-392-21
1998-1997	DODGE	Dakota	V8-5.2L	C.A.R.B. E.O. # D-392-21

* Excludes 2000-2003 Dodge Durango V8 5.9L models equipped with cruise control.

* NOTE: Legal in California only for racing vehicles which may never be used upon a highway

PARTS LIST

Description	Qty.	Part Number
Air Filter Assy. 4.00 X 9" Dry Ele.	1	21-2059DK
Heat Shield	1	20-8200
Inlet Pipe	1	2-82001
Plenum	1	9-8200
Hose, Silicone 4.00x3" Blk.	1	5-400
Edge Trim, 10"	1	8-4010
Mount, Rubber 1" X 6mm	1	1228599
Gskt, TB Spacer	2	2-9203
Gasket, Intake Plenum	1	2-9300
Rubber Edge Trim 16"	1	8-3016
Tb Spacer	1	2-9003N
Screw, Set 1/4-20 X 1"	1	1-2052
Bracket;	1	20-82001
Bracket; Horn	1	32-3035
Bolt, Hex M6-1 X 12mm	1	1-2065
Bolt, Hex 5/16-18 X 3	4	1-2078
Bolt, Intake Plenum	1	1-2082
Washer, 8mm Soft Mount	1	559960
Washer, 6mm Soft Mount	3	08160
Washer, M6 X 12mm OD SS	2	1-3016
washer, M6 x 12mm OD Zinc	1	1-3018
Washer, 5/16 SAE Flat	4	1-3031
Washer, 3/8" Rubber Back	1	1-3033
Nut, M6 Hex Serrated	5	444.460.04
1/2" Bnd. Hose Clamp, 3.56"-4.50"	3	9464

Read and understand these instructions **BEFORE** attempting to install this product. Failure to follow installation instructions and not using the provided hardware may damage the intake tube, throttle body and engine.

1. Preparing Vehicle

- a. Make sure vehicle is parked on level surface.
- b. Set parking brake.
- c. If engine has run in the past two hours, let it cool down.
- d. Disconnect all negative battery terminals.
- e. Do not discard stock components after removal of the factory system.

2. Removal of stock system

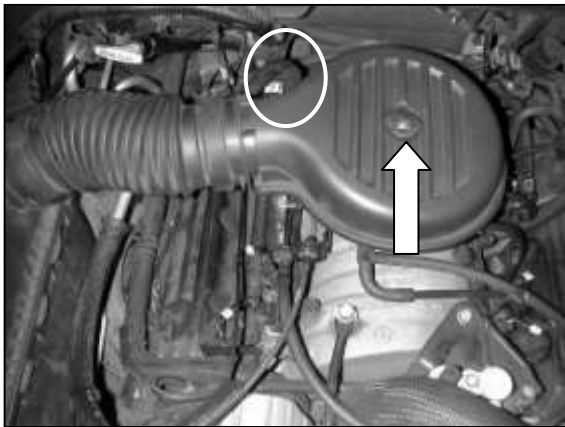

a. Remove the plastic nut shown in the picture. Unplug the breather hose from the back of the intake system.

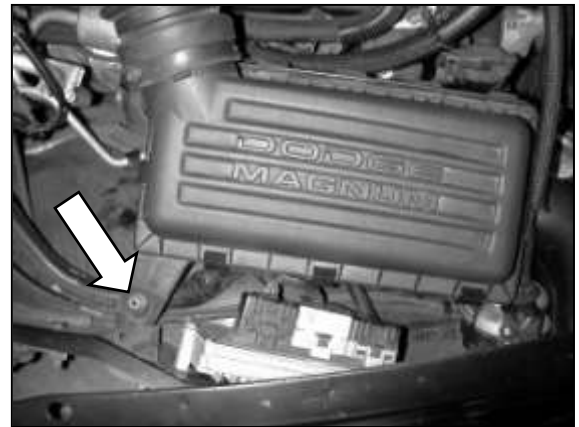

b. Remove the nut shown in the picture. Carefully pull the factory air box upward until it unsnaps from the vehicle.



c. Remove the factory air inlet system from the vehicle.

3. Installing the AEM® Throttle Body Spacer.

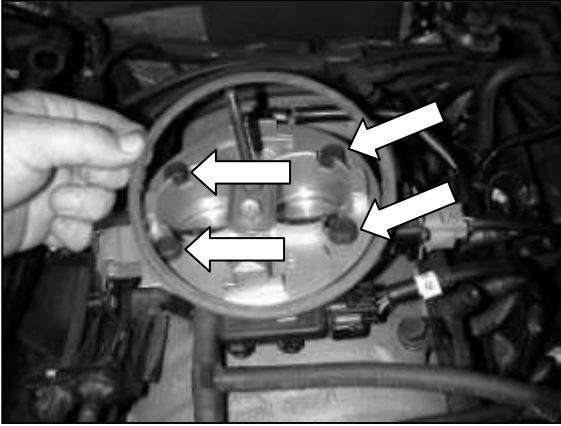

a. Remove the factory gasket. Loosen and remove the four throttle body mounting bolts shown in the picture.



b. Remove the stud assembly from the throttle body.

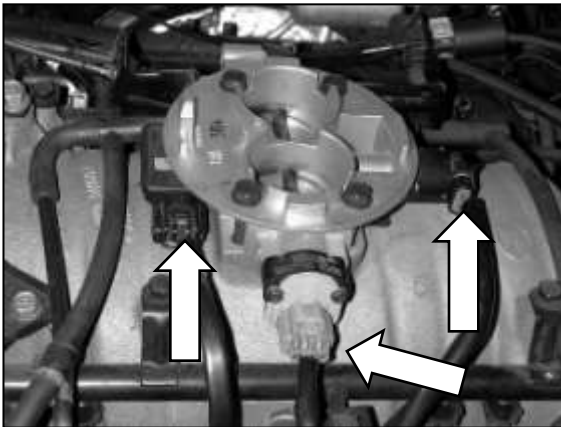

c. Unplug the three electrical connections on the throttle body.



d. Lift up the throttle body and remove the factory gasket. Place the AEM® throttle body spacer on the intake manifold. Use the supplied new gaskets on each side of the spacer. Make sure the spacer is oriented correctly.

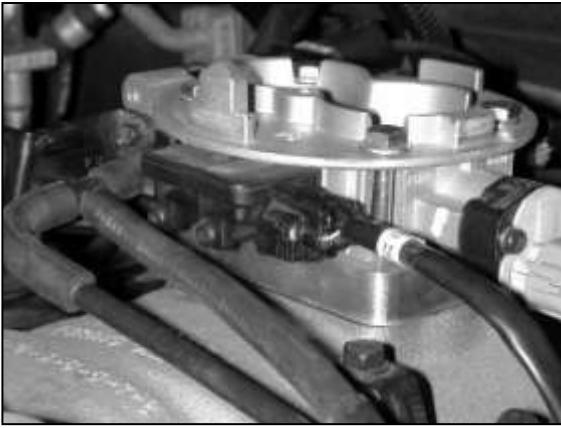

e. Place the throttle body on the spacer and make sure all the holes line up. Secure the throttle body in place using the four supplied bolts and washers. Tighten to 17 ft-lb. Plug in all electrical connections. Open the throttle manually to make sure it works correctly.

4. Modifying Air Horn System

a. If your horns are located as in the picture, you will need to relocate them with the provided hardware. If not, proceed to step 5.

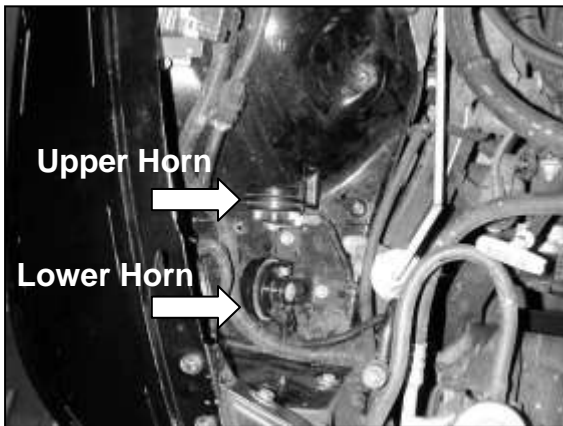

b. Unplug and remove both horns.

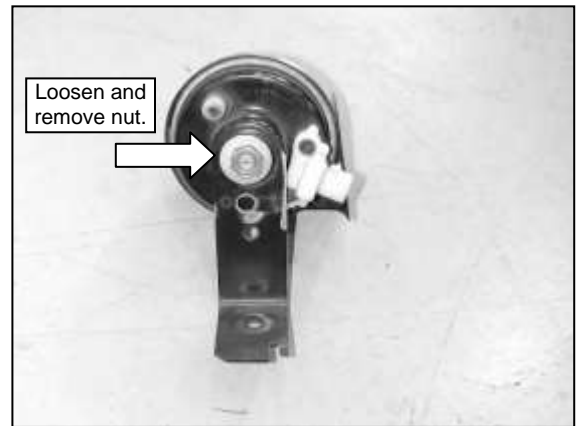

c. Loosen and remove mounting nut and washer.

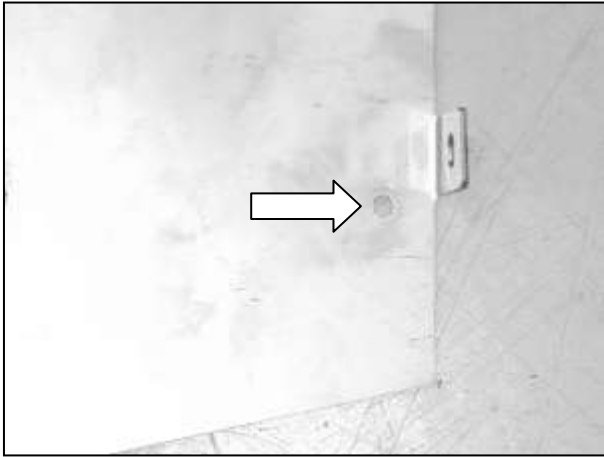

d. Drill 3/8" hole next to the mounting tab. Use provided template.

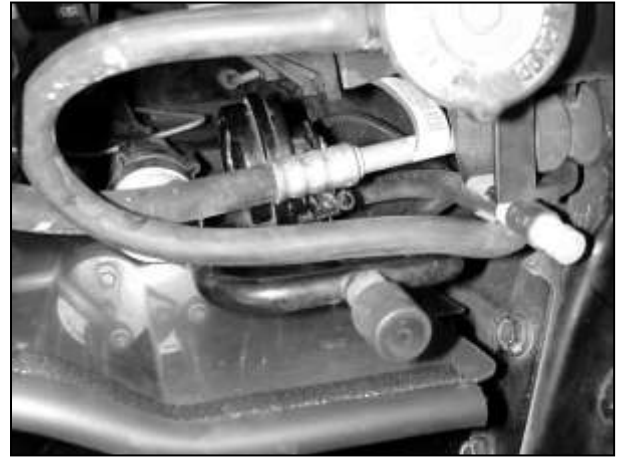

e. See installing AEM® intake system for heat shield installation. The lower horn should be installed as follows. Slide the horn harness underneath the heat shield. Secure the horn to the heat shield with bolt, nylok nut and washer.



f. Reassemble the upper horn to the new bracket with the factory washer and nut. Secure to the mounting stud with provided nylok nut and washer. The horn should point toward the heat shield. Reattach harness.

5. Relocation of Cruise Control System

If your cruise control module is located in front of the factory air box (as seen in the picture below), it will need to be moved to a new location to make room for the AEM intake system. If your cruise control module is located on the firewall, disregard this section and move ahead to step 6.

NOTE: 2000-2003 Dodge Durango V8 5.9L vehicle model's with cruise control are excluded from the applicable vehicle applications for 21-8200.

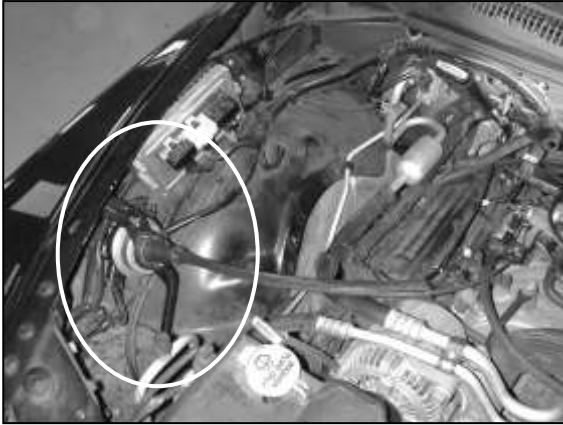

a. Unsnap the cruise control cable from the throttle linkage. Push the cable stop out of the bracket and remove the cable assembly from the throttle body.



b. Unplug the vacuum line for the cruise control from the fitting on the firewall.



c. Unplug the electrical connection from the cruise control unit by pulling the red tab out, then pulling off the connector.



d. Remove the three nuts from the cruise control mounting bracket and remove the unit from the engine bay.

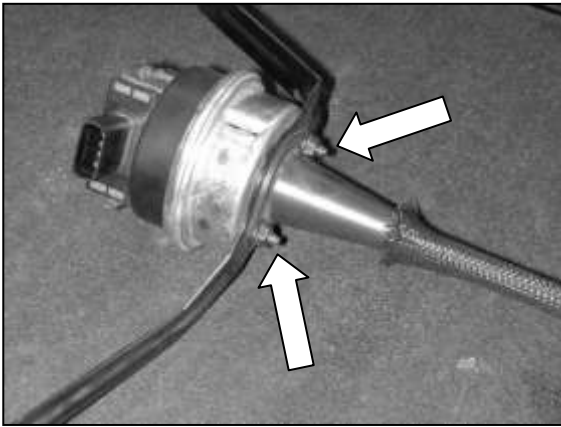

e. Remove the two nuts shown in the picture.

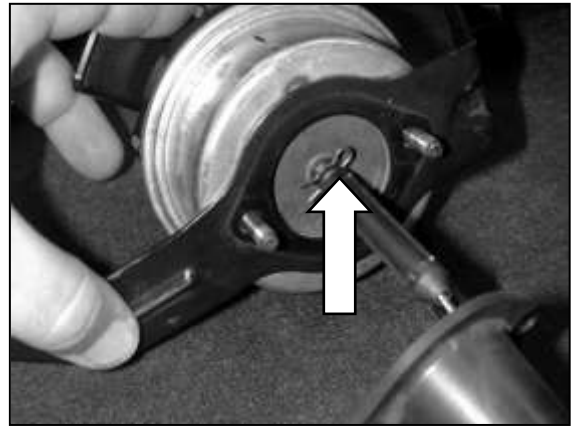

f. Remove the cotter pin from the cable.



g. Remove the mounting bracket from the cruise control assembly.



h. Insert the mounting studs of the cruise control unit into the AEM[®] bracket as shown.



i. Attach the cable to the cruise control unit and re-install the cotter pin.



j. Install the cruise control cable cover and secure it in place by re-using the factory nuts. Make sure the vacuum hose fits in the cut-out as shown.

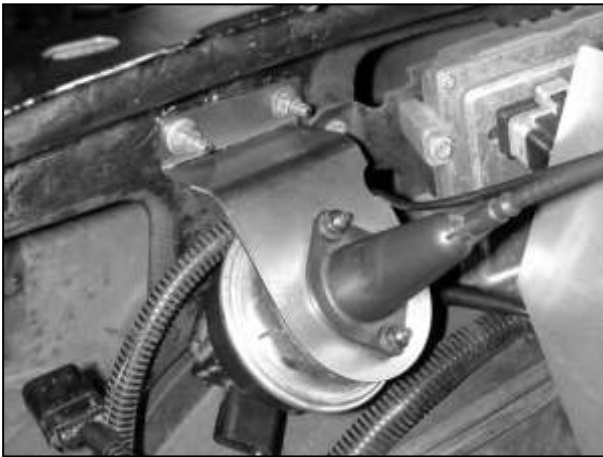

k. Install the cruise control in the vehicle in location of the factory bracket. Secure it in place by re-using 2 of the factory nuts, the third nut will be used to install the heat shield. Plug the cruise control electrical connector in to the unit.



l. Re-attach the cable to the bracket on the throttle body. Snap the end of the cable back on to the throttle linkage control arm. Plug the vacuum line back on to the connector on the firewall.

6. Installation of AEM® intake system.

- a. When installing the intake system, do not completely tighten the hose clamps or mounting hardware until instructed to do so.



b. Remove the plastic fastener holding the inner fender liner in place, as seen in the picture. Unscrew the factory air box mount from the stud on the inner fender.



c. Install the rubber mount, according to the diagram below, in the hole where the plastic fastener was.

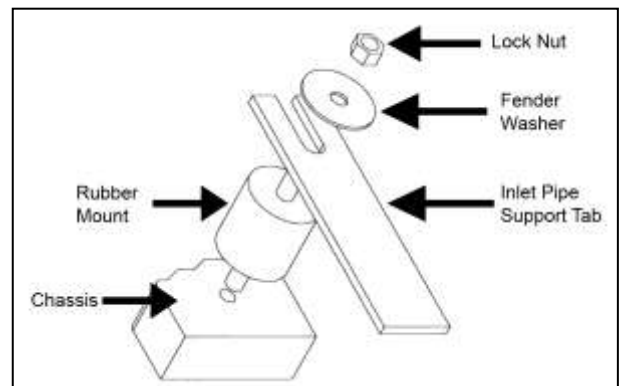

Proper rubber mount assembly installation.



d. From the wheel-well side of the inner fender, secure the rubber mount in place with a fender washer and lock nut.



e. Apply a very thin coat of grease to both sides of the circular rubber gasket included in the kit.



f. Place the circular gasket on the throttle body. Use a hex wrench to install the supplied set screw in to the threaded hole between the throttle body bores (see arrow). It is recommended to use a thread locking compound such as blue loctite.

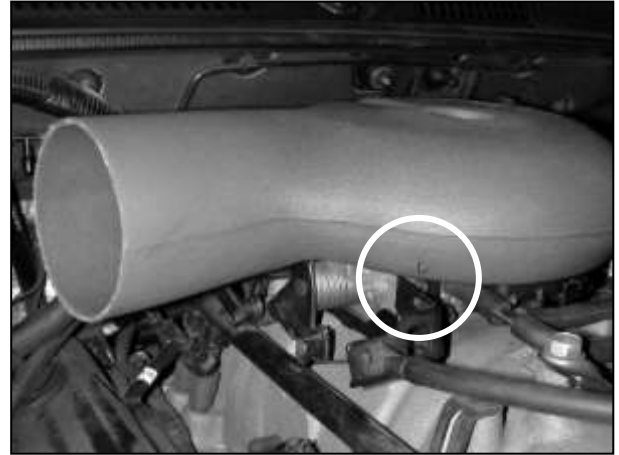

g. Place the upper intake plenum on the throttle body. Line up the arrow with the throttle linkage bracket. Make sure it is sitting flush on the surface of the throttle body. Fully open the throttle by hand and ensure that it does not interfere with upper intake plenum.

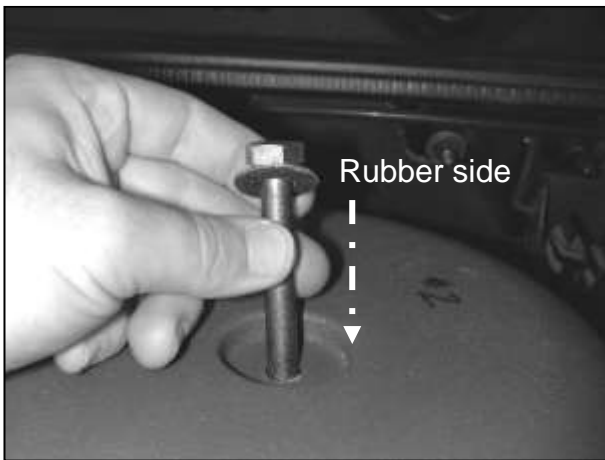

h. Insert the internally threaded bolt into the hole in the upper intake plenum. Use the rubber-bonded washer with the rubber side facing down. Thread the bolt on to the set screw from step f. Tighten the bolt until it bottoms out.

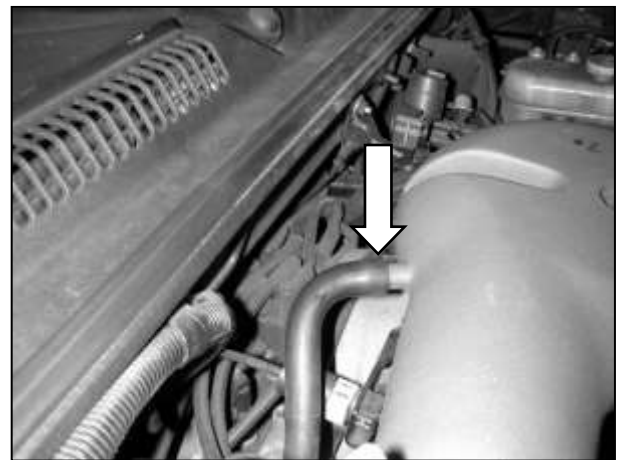

i. Push breather hose onto the fitting on the upper intake piece.



j. Install the silicone coupler on to the end of the upper intake plenum.

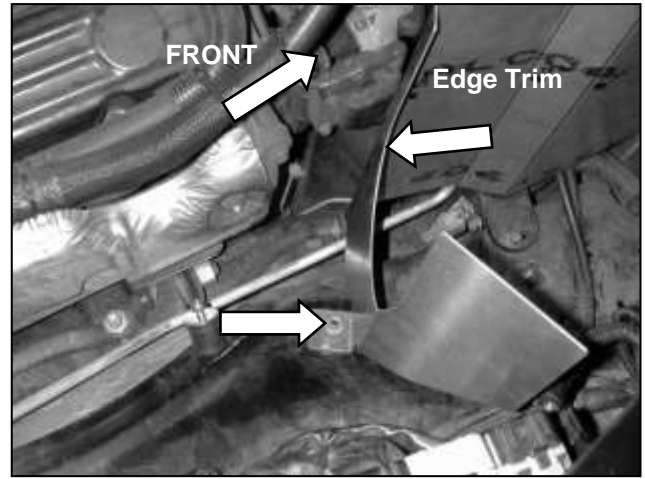

k. Install the heat shield in the engine bay with the U-shaped cut facing to the rear of the vehicle. Insert the rear tab on the heat shield on to the stud on the inner fender. Use the remaining nut from the factory cruise control bracket to secure this tab in place. Install the rubber edge trim on the U-shaped cut on the heat shield.

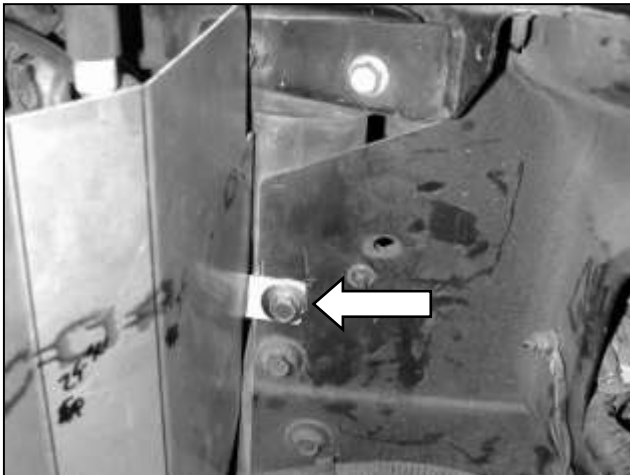

l. Secure the front tab of the heat shield in place using the bolt shown in the picture



m. Insert the intake pipe as shown in the picture. Do not tighten the hose clamps.

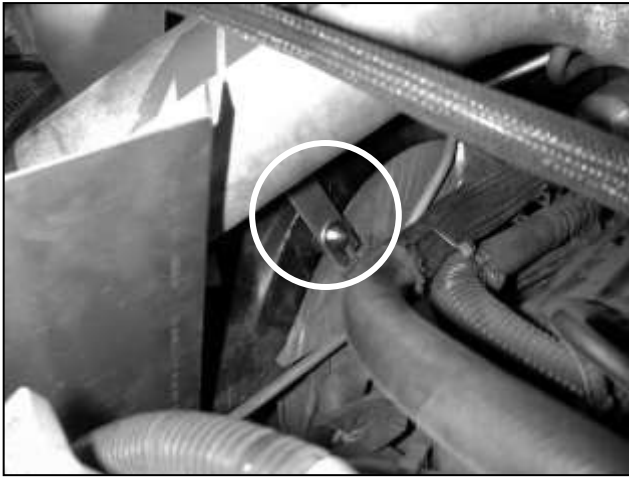

n. Line up the bracket on the pipe with the rubber mount. Install the fender washer and nut on the stud.



o. Install the air filter on to the end of the intake pipe. Orient the intake so that no parts of the filter or pipe touch the vehicle, wiring, or heat shield. When proper placement is achieved, tighten all three hose clamps and the nut on the rubber mount.

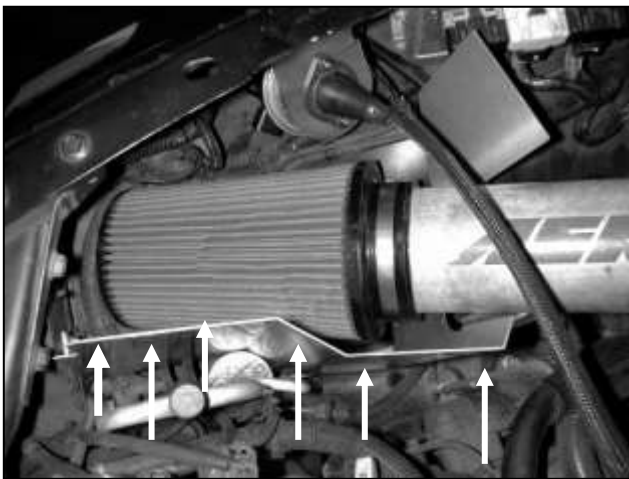

p. Push the piece of rubber molding included in the kit onto the upper edge of the heat shield, denoted by the arrows in the picture.

7. Reassemble Vehicle

- Position the inlet pipes for the best fitment. Be sure that the pipes or any other components do not contact any part of the vehicle. Tighten the rubber mount, all bolts, and hose clamps.
- Check for proper hood clearance. Re-adjust pipes if necessary and re-tighten them.
- Inspect the engine bay for any loose tools and check that all fasteners that were moved or removed are properly tightened.
- Inspect & test throttle linkage for full open and closed throttle before starting and driving the vehicle.
- Reconnect negative battery terminals and start engine. Let the vehicle idle for 3 minutes. Perform a final inspection before driving the vehicle.

8. CARB Sticker Placement

- a. The C.A.R.B. exemption sticker, (attached), must be visible under the hood so that an emissions inspector can see it when the vehicle is required to be tested for emissions. California requires testing every two years, other states may vary.

9. Service and Maintenance

- a. It is recommended that you service your AEM[®] Dryflow™ filter every 20,000 miles for optimum performance. Use AEM Dryflow cleaning kit part # 21-110.
- b. Use aluminum polish to clean your polished AEM intake tube.
- c. Use window cleaner to clean your powder coated AEM intake tube. **(NOTE: DO NOT USE aluminum polish on powder coated AEM intake tubes)**

For technical inquiries e-mail us at sales@aemintakes.com or call us at 800.992.3000

AEM Air Intake System Warranty Policy

AEM[®] warrants that its intake systems will last for the life of your vehicle. AEM will not honor this warranty due to mechanical damage (i.e. improper installation or fitment), damage from misuse, accidents or flying debris. AEM will not warrant its powder coating if the finish has been cleaned with a hydrocarbon-based solvent. The powder coating should only be cleaned with a mild soap and water solution. Proof of purchase of both the vehicle and AEM intake system is required for redemption of a warranty claim.

This warranty is limited to the repair or replacement of the AEM part. In no event shall this warranty exceed the original purchase price of the AEM part nor shall AEM be responsible for special, incidental or consequential damages or cost incurred due to the failure of this product. Warranty claims to AEM must be transportation prepaid and accompanied with dated proof of purchase. This warranty applies only to the original purchaser of product and is nontransferable. Improper use or installation, use for racing, accident, abuse, unauthorized repairs or alterations voids this warranty. AEM disclaims any liability for consequential damages due to breach of any written or implied warranty on all products manufactured by AEM. Warranty returns will only be accepted by AEM when accompanied by a valid Return Merchandise Authorization (RMA) number. Credit for defective products will be issued pending inspection. Product must be received by AEM within 30 days of the date RMA is issued.

If you have a warranty issue, please call (800) 992-3000 and our customer service department will assist you. A proof of purchase is required for all AEM warranty claims.