



Equipped with AEM® Dryflow™ Filter  
No Oil Required!

# **INSTALLATION INSTRUCTIONS**

## **PART NUMBER**

### **21-743C (Gun Metal Grey Finish)**

---

2014-2015 FORD FUSION 2.0L TURBO

**Not legal for sale or use on any pollution controlled motor vehicle in California or states adopting California emission procedures. See [AEMIntakes.com](http://AEMIntakes.com) for CARB status on each part for a specific vehicle.**

ITEM NO.	PART NUMBER	DESCRIPTION	QTY.
1	07529	NUT; M6 HEX SERRATED; GEO	2
2	08275	WASHER; 1/4"ID X 5/8"OD - SAE	2
3	07027	STUD; M6-1.00 M/M, RUBBER MNTD	2
4	2-1516C	TUBE; 2.75"OD X 43", 21-743,	1
5	9444	HOSE CLAMP, 2.31-3.25"	3
6	5-1067	HOSE; HUMP 2.50/2.75 X 3.00" EPDM	1
7	784645	GROMMET, PCV 3/4"ID 1-3/8"OD	1
8	8-139	CONNECTOR, PLASTIC 3/4" 90DEG	1
9	345003	SPRING CLAMP; FBS, 15MM/12M	1
10	5-1305	HOSE; 3/8"ID X 3.5"L	1
11	342008	VENT; 3/8" BARB TO QUICK RELEASE	1
12	784646	GROMMET, 1/2" 3/32 GW	1
13	21-2025DK	AIR FILTER; 2-3/4 X 5 ANGLED FLANGE	1
14	102471	EDGE TRIM; 3/4 BULB, TOP LOC, 35"L	1
15	073140	HEAT SHIELD; 69-3533, MILD STL, TB/PC	1

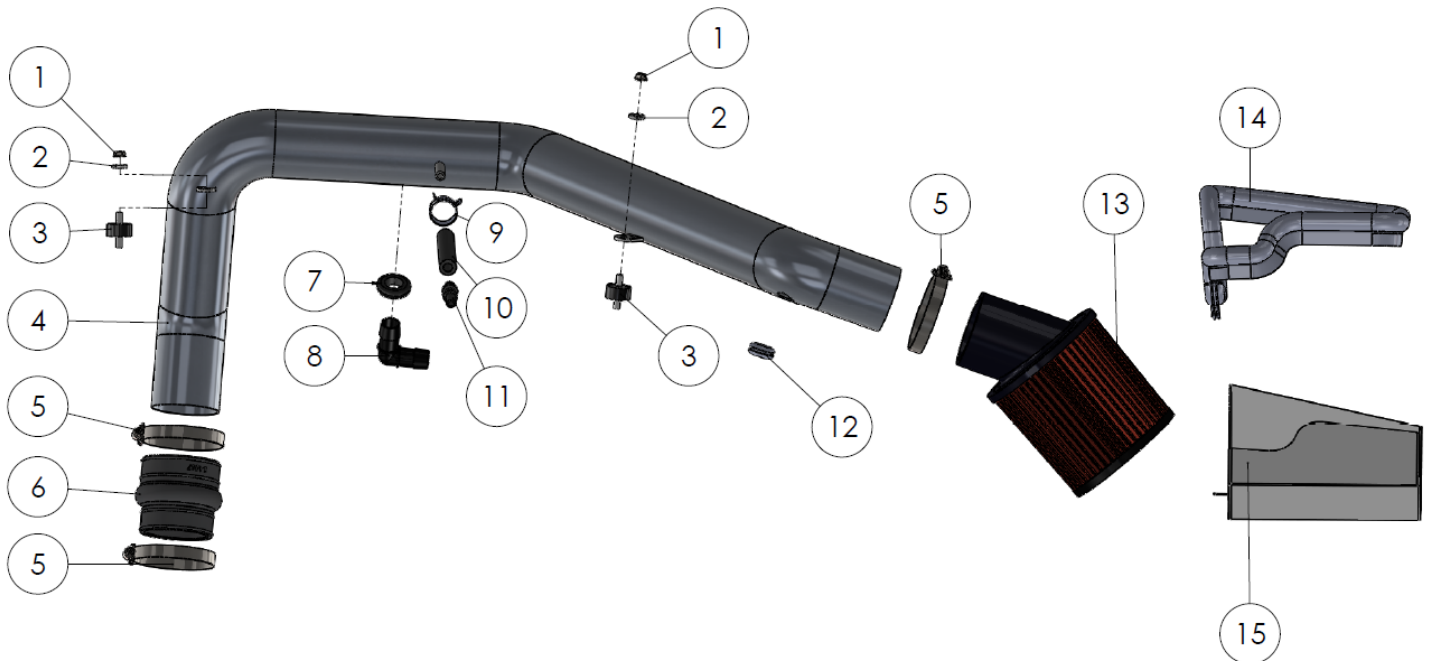

Read and understand these instructions **BEFORE** attempting to install this product. Failure to follow installation instructions and not using the provided hardware may damage the intake tube, throttle body and engine.

## 1. Preparing Vehicle

- a. Make sure vehicle is parked on level surface.
- b. Set the parking brake.
- c. If engine has run in the past two hours, let it cool down.
- d. Disconnect negative battery terminal.
- e. Do not discard stock components after removal of the factory system.
- f. Open the air intake kit package and make sure all parts are included.

### Tools Needed:

Flathead Screwdriver  
10mm Socket  
13mm Deep Socket  
Pliers

## 2. Removal of stock system

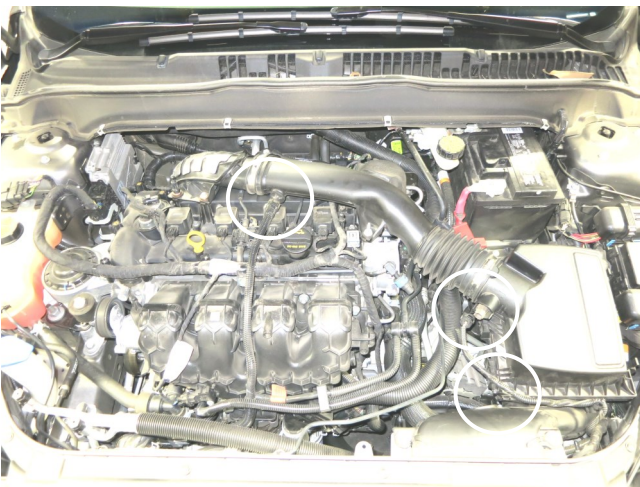

a. Release the vent line and the temperature sensor connector. Also pull the plastic tab out of the air box



b. Pull the two clips back on the air box housing



c. Loosen the hose clamp circled and remove the stud holding the intake tube to the engine.



d. Slide the vent line out of the intake clamp.



e. Remove the stock air filter.



f. Remove the two bolts securing the upper portion of the air intake



g. Squeeze the connector and slide the connector off of the intake tube.



h. Loosen the hose clamp on the end of the upper intake tube.



i. Remove the upper intake tube. Your engine bay should now look like this.

### 3. Installation of AEM® intake system.

a. When installing the intake system, do not completely tighten the hose clamps or mounting hardware until instructed to do so.



a. Install the grommet(784646) into the AEM intake tube.



b. Install the grommet (784645) into the AEM intake tube.



c. Install the 90° connector into the grommet, then install the provided hose/vent/spring clamp onto the AEM intake tube.



d. Install the provided edge trim onto the heat shield as shown.

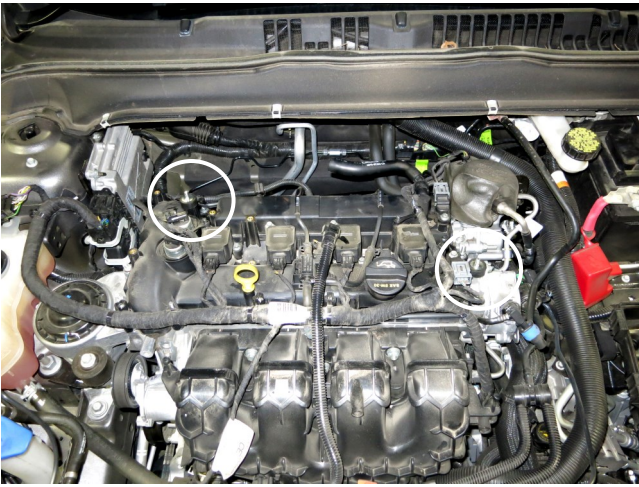

e. Install the provided bushings circled onto the engine.



f. Install the hump hose onto the compressor inlet with the provided hose clamps. Tighten the bottom hose clamp securing it to the turbo compressor.



g. Install the completed heat shield into the lower air box and secure with the factory clips that were removed in step 2b.

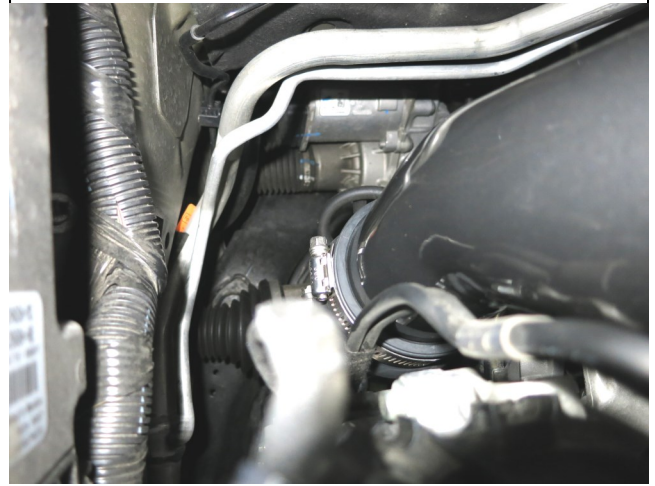

h. Install the AEM intake tube into the previously installed hump hose.



i. Install the AEM intake tube into the engine bay aligning the mounting holes with the bushings.

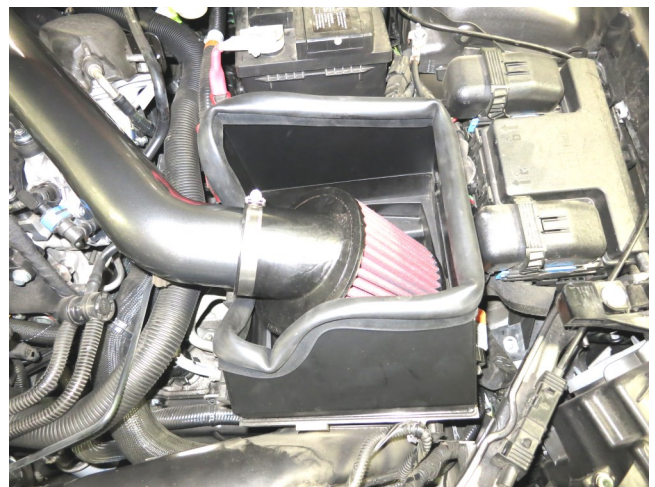

j. Install the AEM filter into the heat shield and onto the AEM tube. Secure the filter to the tube.

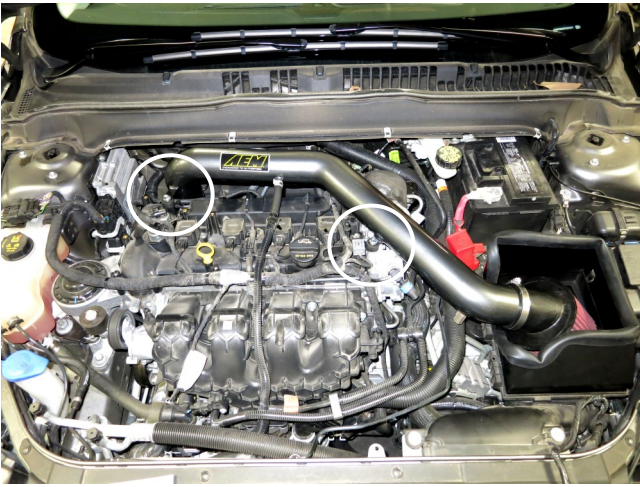

k. Install the washer and nut onto the bushings to secure the tube to the engine. Also tighten the hose clamp on the hump hose that was previously installed in step 3f.



l. Connect the vent tube to the connector coming off the tube.

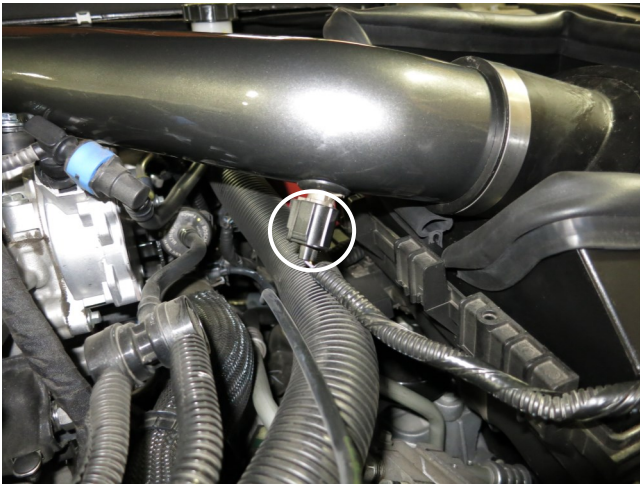

m. Plug in the intake air temperature sensor connector that was disconnected in step 2a.



n. Connect the back vent line to the 90° fitting in the back of the AEM intake tube.



STOCK INTAKE INSTALLED



AEM INTAKE INSTALLED

#### 4. Reassemble Vehicle

- a. Position the inlet pipes for the best fitment. Be sure that the pipes or any other components do not contact any part of the vehicle.
- b. Check for proper hood clearance. Re-adjust pipes if necessary and re-tighten them.
- c. Inspect the engine bay for any loose tools and check that all fasteners that were moved or removed are properly tightened.
- d. Reconnect negative battery terminal and start engine. Let the vehicle idle for 3 minutes. Perform a final inspection before driving the vehicle.

#### 5. Service and Maintenance

- a. AEM Induction Systems requires cleaning the intake system's air filter element every 100,000 miles. When used in dusty or off-road environments, our filters will require cleaning more often. We recommend that you visually inspect your filter once every 25,000 miles to determine if the screen is still visible. When the screen is no longer visible some place on the filter element, it is time to clean it. To clean, purchase our Synthetic air filter cleaner, part number 1-1000 and follow the easy instructions.
- b. Use window cleaner to clean your powder coated AEM<sup>®</sup> intake tube.

**NOTE: DO NOT USE aluminum polish on powder coated AEM<sup>®</sup> intake tubes.**

For technical inquiries  
e-mail us at  
[sales@aemintakes.com](mailto:sales@aemintakes.com)  
or  
call us at  
800.992.3000



## **AEM Air Intake System Warranty Policy**

AEM® warrants that its intake systems will last for the life of your vehicle. AEM® will not honor this warranty due to mechanical damage (i.e. improper installation or fitment), damage from misuse, accidents or flying debris. AEM® will not warrant its powder coating if the finish has been cleaned with a hydrocarbon-based solvent. The powder coating should only be cleaned with a mild soap and water solution. Proof of purchase of both the vehicle and AEM® intake system is required for redemption of a warranty claim.

This warranty is limited to the repair or replacement of the AEM® part. In no event shall this warranty exceed the original purchase price of the AEM® part nor shall AEM® be responsible for special, incidental or consequential damages or cost incurred due to the failure of this product. Warranty claims to AEM® must be transportation prepaid and accompanied with dated proof of purchase. This warranty applies only to the original purchaser of product and is nontransferable. Improper use or installation, use for racing, accident, abuse, unauthorized repairs or alterations voids this warranty. AEM® disclaims any liability for consequential damages due to breach of any written or implied warranty on all products manufactured by AEM®. Warranty returns will only be accepted by AEM® when accompanied by a valid Return Merchandise Authorization (RMA) number. Credit for defective products will be issued pending inspection. Product must be received by AEM® within 30 days of the date RMA is issued.

If you have a warranty issue, please call (800) 992-3000 and our customer service department will assist you. A proof of purchase is required for all AEM® warranty claims.

**Not legal for sale or use on any pollution controlled motor vehicle in California or states adopting California emission procedures. See [AEMIntakes.com](http://AEMIntakes.com) for CARB status on each part for a specific vehicle.**