



Equipped with AEM® Dryflow™ Filter
No Oil Required!

INSTALLATION INSTRUCTIONS

PART NUMBER: 21-699C (Gun Metal Grey Finish)

2007-2010 MINI Cooper S L4-1.6L C.A.R.B. E.O. # D-670-21
2010 MINI Cooper Clubman S L4-1.6L C.A.R.B. E.O. #D-670-21

Intake systems for vehicles listed are 50 state legal. See AEMIntakes.com for CARB status on each part for a specific vehicle.

PARTS LIST

	Description	Qty.	Part Number
A	Tube; Mini Cooper	1	2-1454C
B	Air Box Intake	1	9-0396-1
C	Hood Scoop	1	9-0397-1
D	Heat Shield, Lid	1	20-8517
E	Air Filter	1	21-2027D-HK
F	Gasket, Window	1	5-1060-1
G	Coupler, Elbow, Turbo Inlet	1	5-1061
H	Coupler, Elbow, Air Box Lower	1	5-1058
I	Heat Shield	1	20-8524
J	Hose, 5/32" I.D. X 18"L	1	5-3018
K	Gasket, EPDM Trim-Seal 16" L	1	8-6016
L	Hose; 2-3/4" Id X 1-1/2" L Reinforced	1	08179
M	Grommet; 3/8"ID X 1-5/8"OD X 1-1/4" Panel Hole X 3/16" Gap	1	784643
N	Rivet, Push-in, Nylon, Ribbed Shank, .281 Hole, .062-1.0" Mat	4	8-174
O	Spacer, Alum 0.500" OD X 0.250" ID X 2-1/8"L	2	7-252
P	Bolt; Hex M6-1 X 65mm	2	1-2095
Q	Hose Clamp, 2.31-3.25"	3	9444
R	Hose Clamp, 1.75	1	103-BLO-2820
S	Bolt; Button Head M6-1.0 X 10mm	6	1-112
T	Washer, #12 Nylon 6/6	4	1-3001
U	Washer, M6 X 12mm OD Zinc	2	1-3018
V	Washer, M6 Split Lock Zinc	7	1-3025
W	Filter Minder, 10"	1	35-80311
X	Bracket; Support Filter Minder	1	32-3017
Y	Bolt; Hex M6-1 X 12mm	3	1-2065
Z	Grommet, 1/2"	1	784634
AA	Elbow, Plastic 5/32" 90 Degree	1	8-152
AB	Mount, Plastic Air box	3	8-186
AC	Hose, 1/4" I.D., 1.0" Long	1	5-6001
AD	1/2" Bndhose Clamp, 2.56"-3.50"	1	9448

Kit Illustration

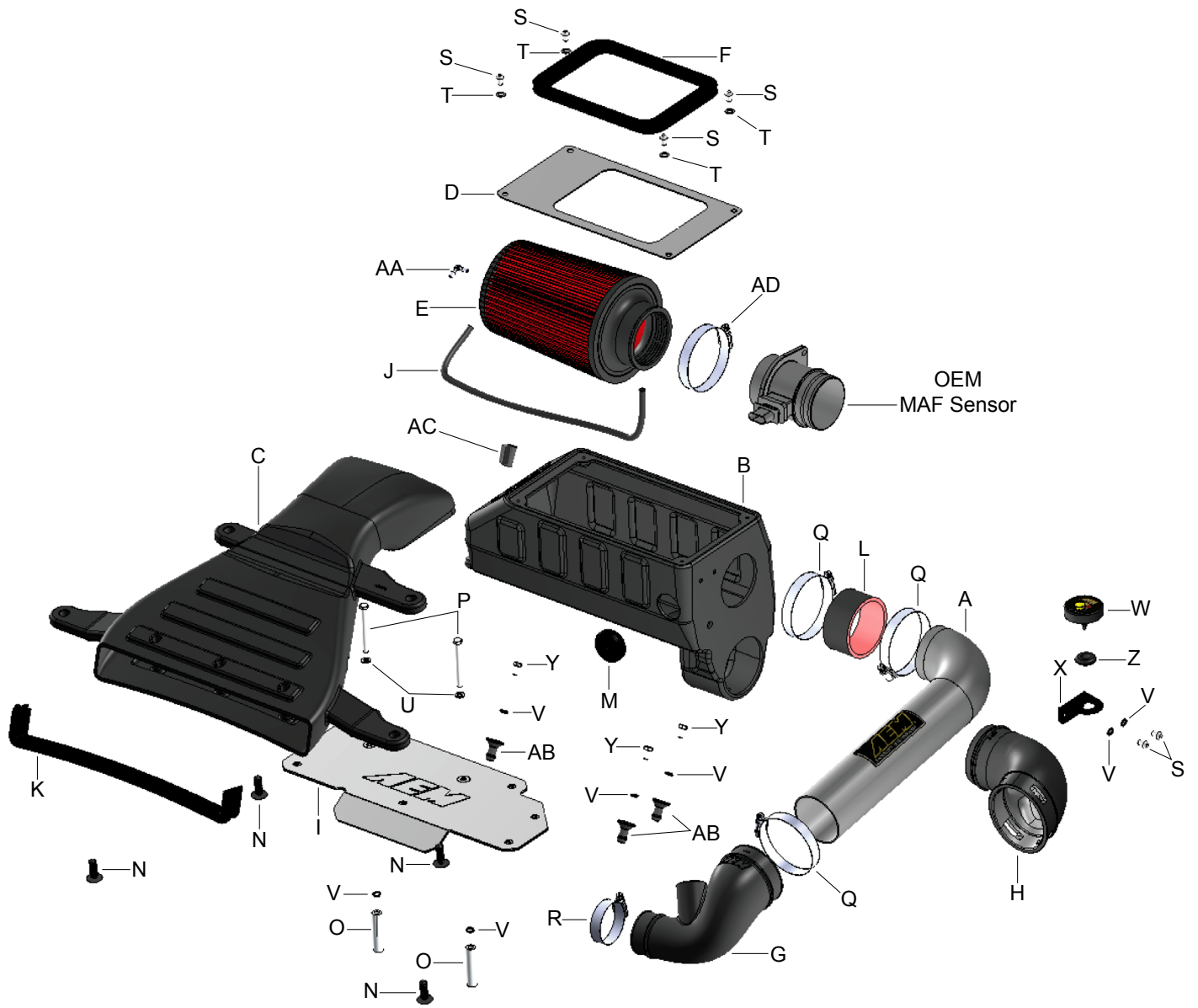

Read and understand these instructions **BEFORE** attempting to install this product. Failure to follow installation instructions and not using the provided hardware may damage the intake tube, throttle body and engine.

The AEM® intake system is a performance product that can be used safely during mild weather conditions. During harsh and inclement weather conditions, you must return your vehicle to stock OEM air box and intake tract configuration. Failure to follow these instructions will void your warranty.

1. Preparing Vehicle

- a. Make sure vehicle is parked on level surface.
- b. Set parking brake.
- c. If engine has run in the past two hours, let it cool down.
- d. Disconnect negative battery terminal.
- e. Do not discard stock components after removal of the factory system.

2. Removal of stock system

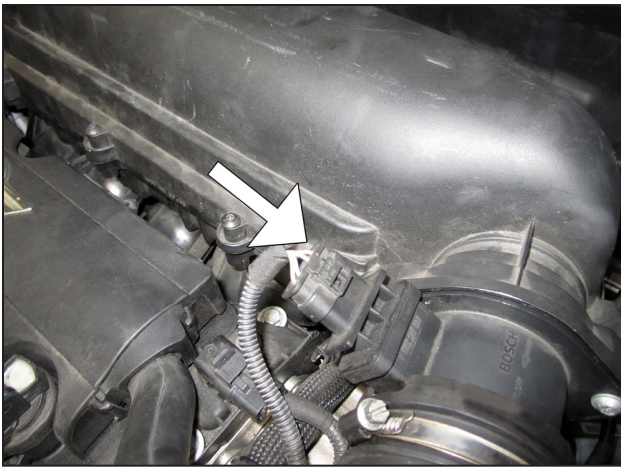

a. Disconnect the MAF sensor wiring harness at the MAF sensor housing by pushing down the small lock tab and pulling on the connector.



b. To remove the stock intake tube, disconnect the turbo bypass tube from the stock intake and loosen the 2 hose clamps retaining the intake tube.



c. To remove the stock MAF sensor housing, remove the 2 screws retaining the MAF housing to the upper air box lid, then remove the large o-ring from the MAF sensor outlet.

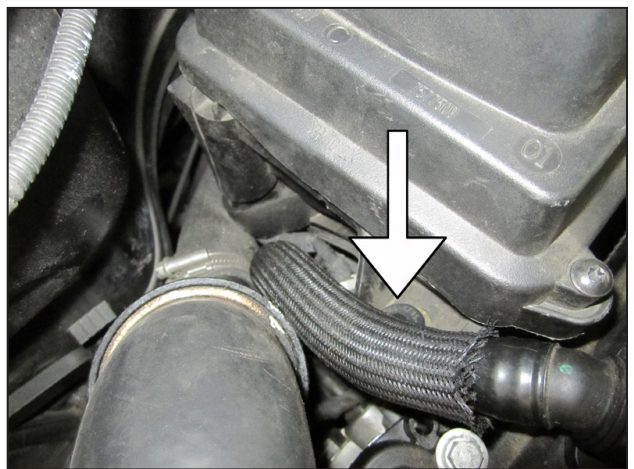

d. Remove the lower Torx screw and plastic grommet insert at the passenger side foot of the stock air box using a T20 Torx bit. Retain the Torx screw for future use.

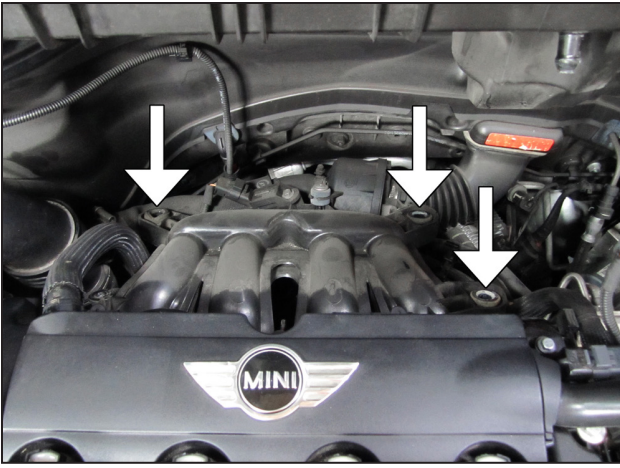

e. Pull up on the stock air box assembly carefully until it pops free from the 3 rubber mounting grommets on the intake manifold. Make sure all 3 rubber grommets stay in the intake manifold.

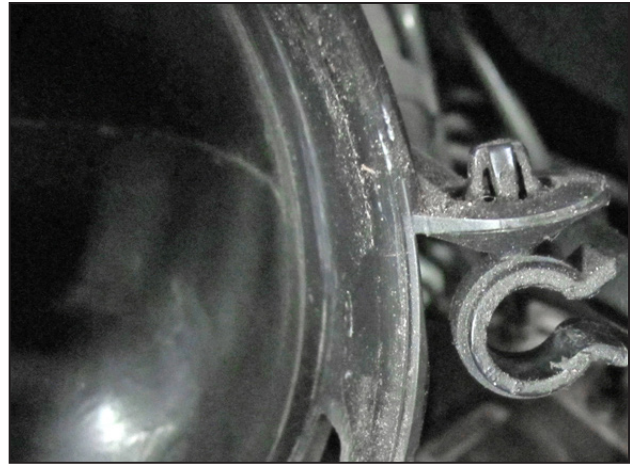

f. Unclip the plastic vacuum line from the lower intake elbow.

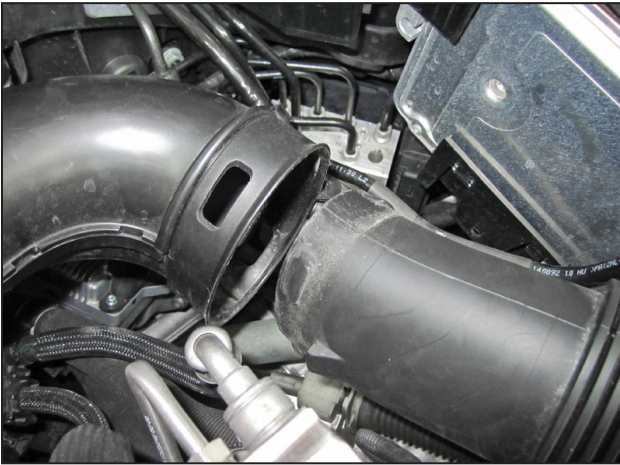

g. To completely remove the air box assembly, disconnect the air box inlet elbow (left) from the stock intake tube (right) by squeezing on the intake tube and pulling it free from the 4 locking slots in the intake elbow.

3. Installation of AEM® Intake System

a. When installing the intake system, do not completely tighten the hose clamps or mounting hardware until instructed to do so.



b. Install the 3 black heat shield mounting nipples (8-186) onto the bottom of the air box (9-0396) as shown using 3 of the M6 hex bolts (1-2065) and 3 of the split washers (1-3025) inside the air box. Fully tighten the 3 bolts and washers inside the air box.

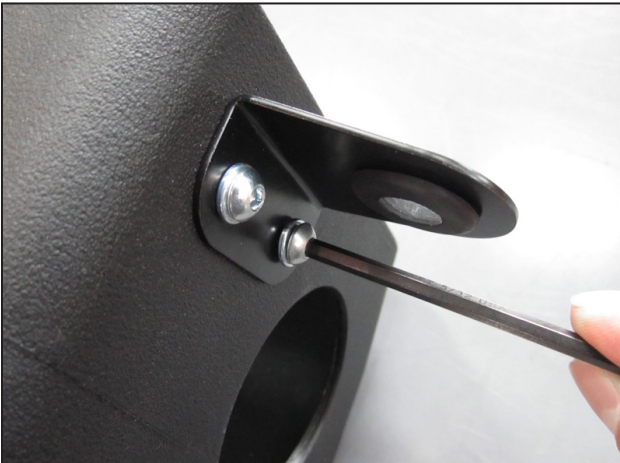

d. Mount the filter minder support bracket onto the brass inserts on the side of the air box using 2 of the M6 buttonhead bolts (1-112) and 2 of the split washers (1-3025). Fully tighten the bolts with a 4mm allen wrench.



c. Install the smaller grommet (784643) into the black filter minder support bracket (32-3017) as shown.



e. Mount the AEM® filter minder gauge (35-80311) into the grommet of the support bracket and orient as shown. Use glass cleaner or a silicone lubricant to ease installation into the grommet. If necessary, reset the gauge needle so it points to the green section of the indicator.



f. Install the stock MAF sensor housing into the large upper hole inside the air box (9-0396) as shown. The 2-bolt flange should face left toward the inside of the air box.



g. Rotate the MAF sensor housing in the hole until the MAF sensor connector is aligned with the access hole in the front of the air box as shown.



h. Install the short reinforced hose (08179) over the inlet flange of the MAF housing on the outside of the air box with a #44 hose clamp as shown. Fully tighten the hose clamp.



i. Install the small elbow fitting (8-152) into the small hole in the cap of the Dryflow™ air filter (21-2027D-HK) as shown.



j. Install the long 5/32" hose (5-3018) over the elbow fitting as shown.

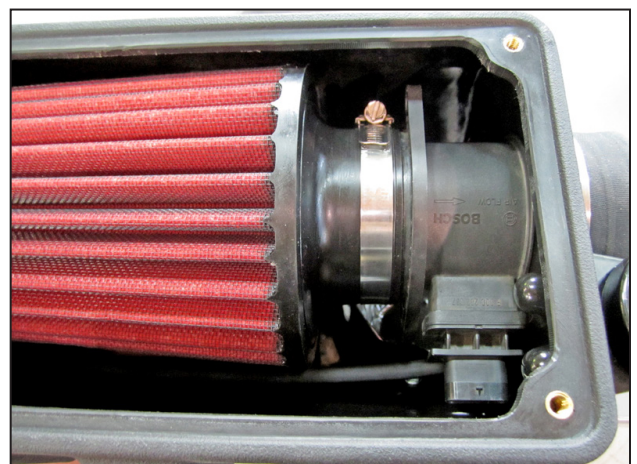

k. Inside the air box, install the AEM® Dryflow™ air filter onto the outlet of the MAF sensor housing with a #44 hose clamp as shown. Fully tighten the hose clamp.



l. Push the long 5/32" hose attached to the air filter's cap through the 3/8" hole on the side of the air box and connect it to the port of the AEM® filter minder gauge as shown. Trim the hose as needed.



n. If your AEM® air box has a larger 1/2"-inch hole in the mounting foot, cut the 1/2"-inch hose (5-6001) to match the length of the hole in the mounting foot (approximately 0.6" or 5/8") as shown.



p. Partially insert the stock Torx screw into the rubber hose as shown. The hose will work as an expansion grommet upon installation.

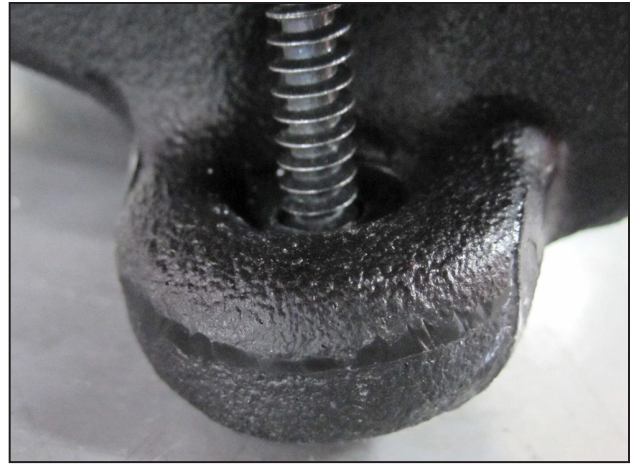

m. If your AEM® air box (9-0396-1) has a small 1/4-inch hole in the mounting foot, install the stock Torx screw (Removed in Step 2d) into the mounting foot as shown. Proceed to Step 3q.



o. Insert the cut hose (5-6001) into the mounting foot hole until it is flush with the bottom face as shown.



q. Install the new air box assembly onto the 3 stock mounting grommets on the intake manifold.



r. Align the torx screw in the mounting foot to the lower passenger side mounting pad on the intake manifold. Fully tighten the screw with a T20 Torx driver until it is fully seated in the intake manifold's mount.

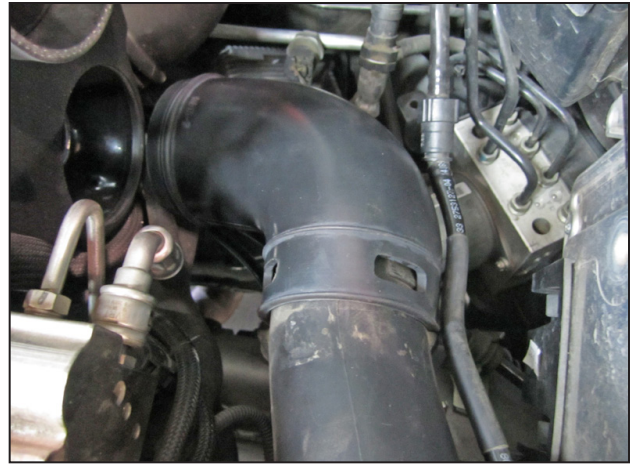

s. Install the oval end of the rubber elbow intake coupler (5-1058) over the outlet of the stock plastic intake tube. Fully seat the coupler until the 4 plastic lock tabs fit into the 4 slots in rubber elbow coupler.



t. Insert the round end of the elbow coupler (5-1058) into the lower inlet hole of the air box. Make sure it is fully seated.



u. Place the large split grommet (784634) over the MAF wiring harness as shown. Note that that MAF harness has been re-routed underneath the other engine sensor harness to maximize slack.



v. Connect the MAF harness connector to the MAF sensor housing inside the air box as shown.



w. Fully seat the split grommet (784634) into the MAF sensor access hole in the front of the air box to completely seal the hole as shown.

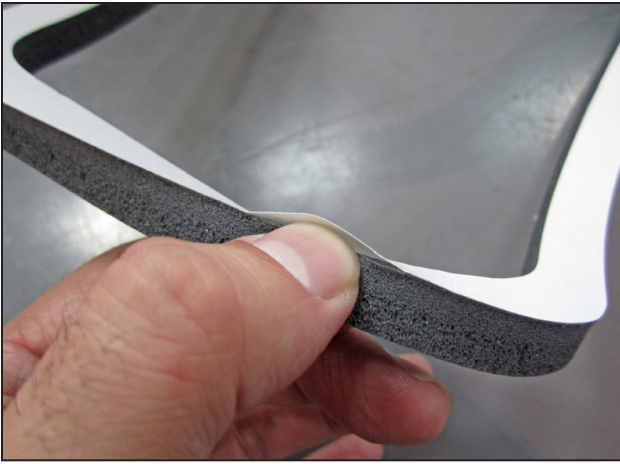

x. Remove the waxed paper backing from the silicone foam window gasket (5-1060-1) by pinching the gasket on its sides, then peeling up the edge of exposed paper. **DO NOT USE A KNIFE TO REMOVE THE PAPER BACKING.**



y. Place the powder coated air box heat shield lid (20-8517) on a table with the part number stamp facing **DOWNWARD**. Apply the adhesive side of the silicone gasket (5-1060-1) on top of the heat shield, aligning it with the window cutout as shown. Press down on the foam gasket to ensure adhesion to the heat shield lid.
NOTE: The adhesive must set for a full 24 hours before use for best results.

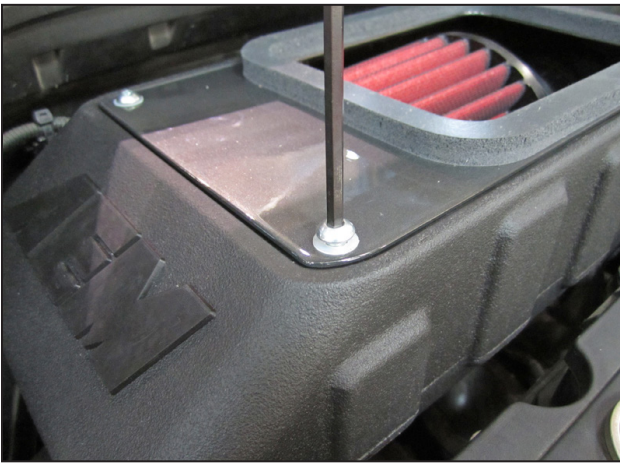

z. Mount the heat shield lid assembly onto the air box using 4 M6 buttonhead bolts (1-112) and 4 plastic washers (1-3001); tighten using a 4mm Allen wrench. Start all 4 bolts before fully tightening.



aa. Loosely install the turbo elbow coupler (5-1061) onto the turbocharger inlet using the provided #28 hose clamp. Fully seat the turbo bypass connector into the bypass port of the coupler. Use glass cleaner to ease installation of the interference-fit connector into the bypass port if necessary.



ab. Loosely install the intake tube (2-1454) into the turbo coupler and then into the short hose (08179) on the air box side using 2 #44 hose clamps. Adjust the tube until it is straight alongside the engine and then fully tighten all 3 hose clamps.

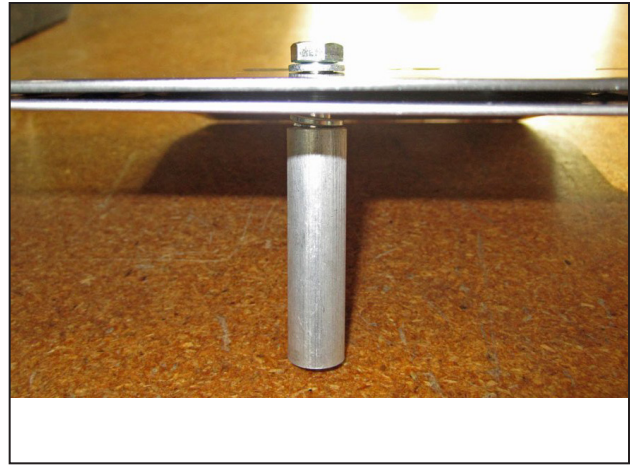

ac. Assemble the 2 M6 x 65mm hex bolts (1-2095), 2 flat washers (1-3018), 2 split washers (1-3025), and 2 aluminum spacers (7-252) so the hex bolts slide through the turbo heat shield (20-8524) holes and into the aluminum spacers as shown. Assemble the parts so that the flat washers mount on top of the heat shield and the split washers are sandwiched by the heat shield and aluminum spacers. Ensure that the AEM® logo on the turbo heat shield is facing up.

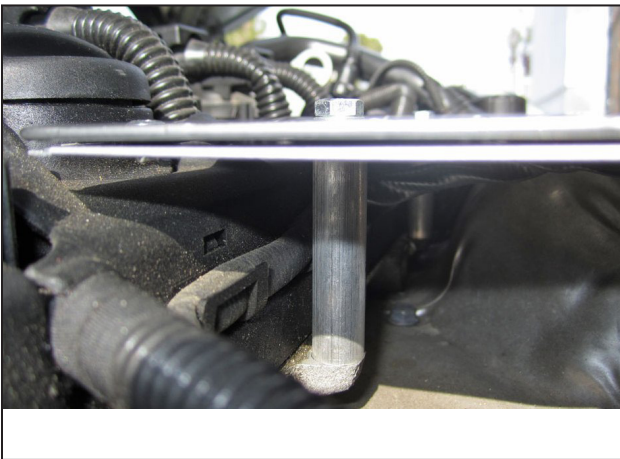

ad. Mount the 2 long hex bolts of the turbo heat shield assembly into the 2 M6 mounting bosses at the edge of the cylinder head as shown.



ae. Fully tighten the 2 long hex bolts until the washers and spacer are seated. Pull up on the turbo heat shield (20-8524) to ensure there is about a 1/8" air gap between it and the stock turbocharger heat shield wrap.

NOTE: The AEM® aluminum heat shield is required to protect your AEM® cold air hood scoop from excess heat.

4. Installation of the AEM® cold air hood scoop

a. When installing the intake system, do not completely tighten the hose clamps or mounting hardware until instructed to do so.

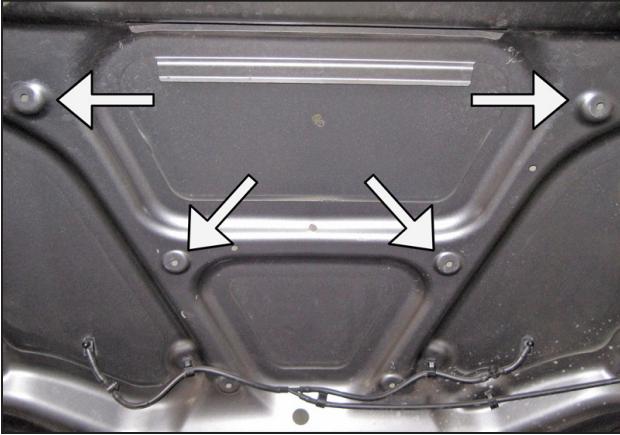

b. Remove the 4 screws retaining the hood insulation under the vehicle's hood. Remove the insulation pad. Note the 4 insulation pad mounting holes on the under hood bracing.



d. Place the hood scoop bezel face down onto a clean cloth or towel to prevent scratching. Remove the 4 small Phillips screws retaining the air restrictor grill. Remove the grill.



c. Temporarily close the vehicle's hood. Carefully pull up at the rear center of the factory hood scoop bezel using small fingertips or a flathead screwdriver covered in tape and a soft cloth until it pops free from the hood. Carefully pull up on the remaining mounting tabs to remove the bezel.



e. Re-install the now fully open hood scoop bezel onto the vehicle hood by popping the mounting tabs back into position by hand. DO NOT use a mallet to force them in.

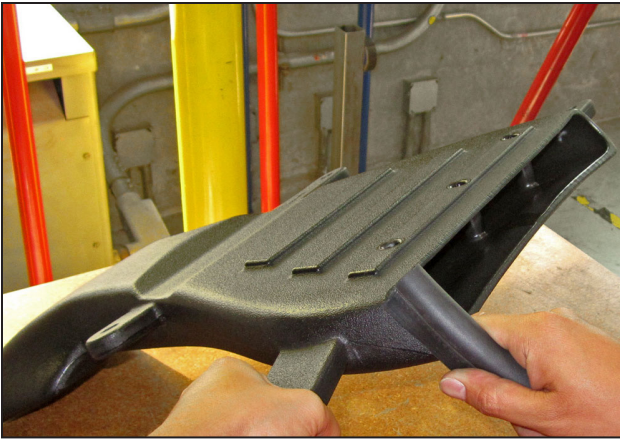

f. Install the edge trim (8-6016) onto the lower lip and sides of the cold air hood scoop's inlet. Ensure the edge trim is even on both sides of the inlet and is fully seated; use the heel of your hand or a light rubber mallet to fully seat.



h. In some vehicles, you may need to unclip the windshield washer hose under the hood to prevent the hose from being pinched. Re-route the hose around the back of the new hood scoop and then re-clip the hose.

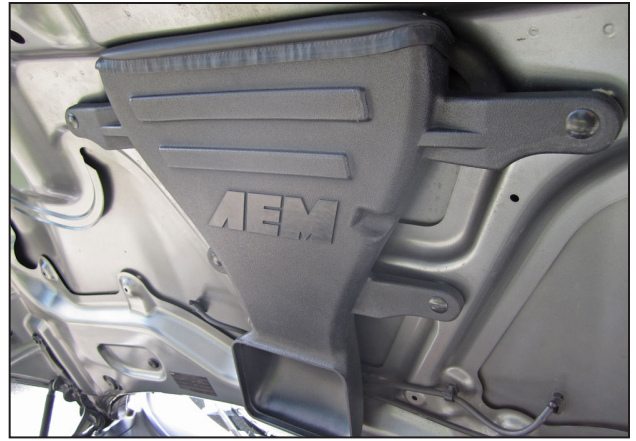

g. Open the vehicle's hood. Mount the AEM® cold air hood scoop onto the underside of the hood by mounting the plastic push rivets (8-174) into the 4 insulator pad mounting holes by hand. Ensure the 4 push rivets are fully seated and properly secure the AEM® hood scoop in place. Make sure the edge trim of the AEM® hood scoop inlet fully seals around the cutout in the underside of the vehicle hood.



AEM® intake system installed

5. Reassemble Vehicle

- a. Position the inlet pipes for the best fitment. Be sure that the pipes or any other components do not contact any part of the vehicle. Tighten the rubber mounts (if applicable), all bolts, and hose clamps.
- b. Check for proper hood clearance. Re-adjust pipes if necessary and re-tighten them.
- c. Inspect the engine bay for any loose tools and check that all fasteners that were moved or removed are properly tightened.
- d. Reconnect the negative battery terminal and start the engine. Let the vehicle idle for 3 minutes. Perform a final inspection before driving the vehicle.

6. CARB Sticker Placement

- a. The C.A.R.B. exemption sticker, (attached), must be visible under the hood so that an emissions inspector can see it when the vehicle is required to be tested for emissions. California requires testing every two years, other states may vary.

7. Service and Maintenance

- a. AEM Induction Systems requires cleaning the intake system's air filter element every 100,000 miles. When used in dusty or off-road environments, our filters will require cleaning more often. We recommend that you visually inspect your filter once every 25,000 miles to determine if the screen is still visible. When the screen is no longer visible some place on the filter element, it is time to clean it. To clean, purchase our Synthetic air filter cleaner, part number 99-0624 and follow the easy instructions.
- b. Use window cleaner to clean your powder coated AEM® intake tube.

NOTE: DO NOT USE aluminum polish on powder coated AEM® intake tubes.

For technical inquiries
e-mail us at
sales@aemintakes.com
or
call us at
800.992.3000

AEM Air Intake System Warranty Policy

AEM® warrants that its intake systems will last for the life of your vehicle. AEM will not honor this warranty due to mechanical damage (i.e. improper installation or fitment), damage from misuse, accidents or flying debris. AEM will not warrant its powder coating if the finish has been cleaned with a hydrocarbon-based solvent. The powder coating should only be cleaned with a mild soap and water solution. Proof of purchase of both the vehicle and AEM intake system is required for redemption of a warranty claim.

This warranty is limited to the repair or replacement of the AEM part. In no event shall this warranty exceed the original purchase price of the AEM part nor shall AEM be responsible for special, incidental or consequential damages or cost incurred due to the failure of this product. Warranty claims to AEM must be transportation prepaid and accompanied with dated proof of purchase. This warranty applies only to the original purchaser of product and is nontransferable. Improper use or installation, use for racing, accident, abuse, unauthorized repairs or alterations voids this warranty. AEM disclaims any liability for consequential damages due to breach of any written or implied warranty on all products manufactured by AEM. Warranty returns will only be accepted by AEM when accompanied by a valid Return Merchandise Authorization (RMA) number. Credit for defective products will be issued pending inspection. Product must be received by AEM within 30 days of the date RMA is issued.

If you have a warranty issue, please call (800) 992-3000 and our customer service department will assist you. A proof of purchase is required for all AEM warranty claims.

Intake systems for vehicles listed are 50 state legal. See AEMIntakes.com for CARB status on each part for a specific vehicle.