



# Installation Instructions

## *Precision Sport Shifter*

### *2004 and up Pontiac GTO*

(see [www.bmracing.com](http://www.bmracing.com) for the latest vehicle fitment applications and model years)  
**Part Number 45043**

©2010, 2005, 2004 by B&M Racing and Performance Products





This **B&M Precision Sport Shifter** has been designed to work on most 2004 and up Pontiac GTO model vehicles equipped with a manual transmission. It has been engineered to greatly reduce shift throw and improve shifter feel. Check the parts and tools lists at the beginning of these instructions for the supplied parts and the tools required to install your **B&M Precision Sport Shifter**. Installation of this **B&M Precision Sport Shifter** can be accomplished by anyone with minimal mechanical experience.



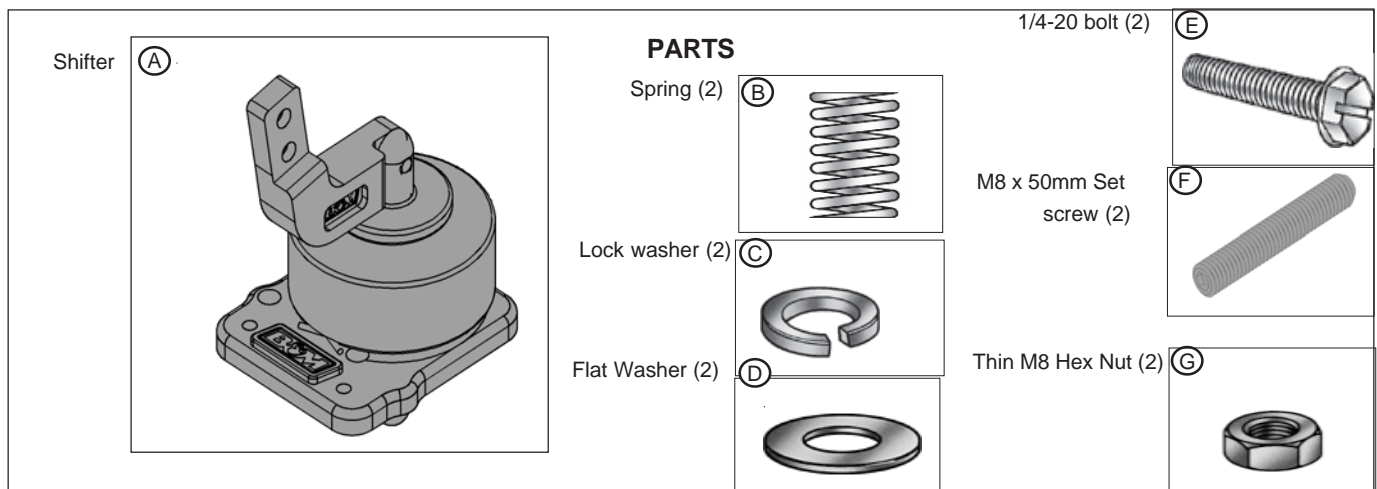





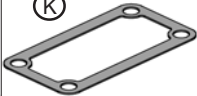



#### INTRODUCTION

This **B&M Precision Sport Shifter** can be installed in less than two hours by carefully following the instructions. Read all instructions first to familiarize yourself with the parts, tools, and procedures. This kit contains all the parts necessary to install the shifter.

Please note that vehicles used in competition or vehicles that my experience extreme vibration and/or heat may require lock wiring (safety wiring) and/or other methods to prevent some fasteners from loosening.



5/16-18 bolt (2) <b>(H)</b>		<b>PARTS(CONTINUED)</b>		Top Stick <b>(L)</b>	
M8 Hex Nut (2) <b>(I)</b>		Thread Adhesive <b>(J)</b>			
		Trans Gasket <b>(K)</b>			

<b>TOOLS</b>					
Socket(13 & 10mm)		Socket Drive		Extension	
Pliers		Hex Wrench (1/4, 3/16, 5/32, 4 & 6mm)		Screwdriver (flat)	
Torx 25		Jack		Jack Stands (x4)	
Vise & Hammer		Wrench (13mm & 3/4)		Screwdriver (phillips)	

## DISASSEMBLY

**STEP 1.** Remove screw at front of console.  
TOOL: Screwdriver (philips)



**STEP 2.** Lift up storage compartment at rear of center console and pull up on center console. Unplug wire connectors for windows and traction control.



**STEP 3.** Pull up and remove center console.



**STEP 4.** Pull up on plastic retainer for shift boot.



**STEP 5.** Remove bolts (2) securing top stick of stock shifter.  
TOOLS: 10mm socket & Drive.



**STEP 6.** Raise vehicle.  
TOOLS: Jack, Jack stands (4)

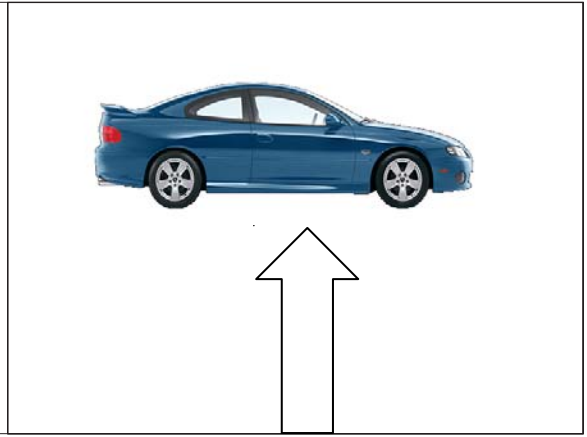

**STEP 7.** Remove nuts (4) holding down rubber boot.  
TOOLS: 13mm socket, Extension, Drive & 13mm wrench.



**STEP 8.** Remove rubber boot.



**STEP 9.** Remove torx screws (4) holding down shift cover and remove.  
TOOLS: T-25 drive screwdriver.



**STEP 10.** Remove bolts (4) and screws (3) holding down shifter.  
TOOLS: 1/4" socket, Extension, Drive & Screwdriver (phillips)



**STEP 11.** Pull out entire stock shifter assembly, including o-ring.



**STEP 12.** Remove bolts (2) holding down GTO trans base.  
TOOLS: 6mm Hex, Extension & Drive

OPTIONAL: Front (2) bolts of GTO trans base can be removed, GTO trans base removed and gasket can be replaced.

GTO Trans base



**STEP 13.** Remove stock knob by holding stick in vise and hitting knob with wrench.

TOOLS: 3/4" Wrench, Hammer & Vise



## ASSEMBLY

**STEP 14.** Install B&M shifter using (2) 1/4-20 bolts, (2) lock washers, (2) M8 nuts, (2) M8 thin nuts and (2) M8 washers.

(SEE DIAGRAM BELOW FOR DETAILS)

TOOLS: Screwdriver (flat), Hex Wrench (6mm), thread adhesive, and wrench (13mm)

**NOTE: FAILURE TO USE THREAD ADHESIVE COULD RESULT IN SHIFTER MALFUNCTION.**

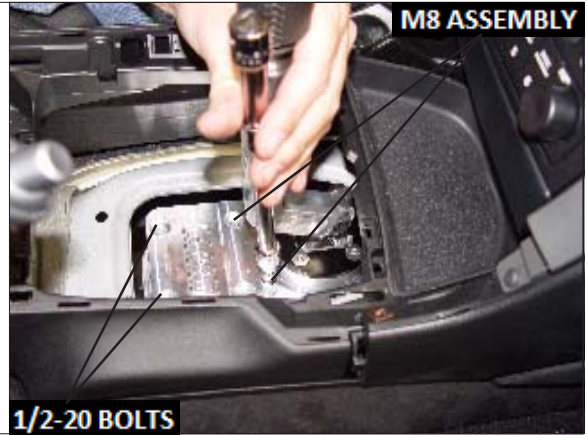

Torque 1/4-20 bolts to 8-10 ft-lbs.  
Caution do not overtorque bolts!!  
Torque M8 thin nuts to 8-10 ft-lbs.  
Torque M8 nuts to 15 ft-lbs.

Leave approx. 0.9" of M8 set screw thread above GTO Trans after locking down GTO Trans.

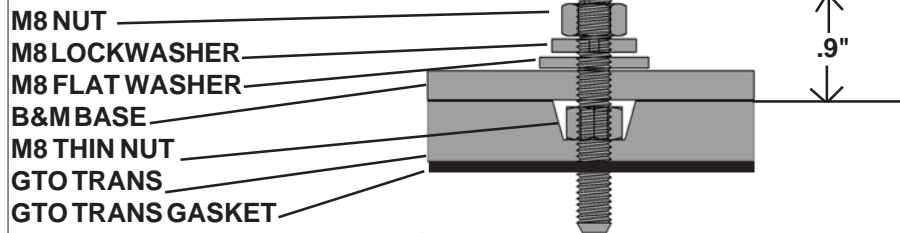

**STEP 15.** Reinstall rubber boot.

**NOTE:** On some earlier models a black boot was used which may need some trimming of the opening to allow for full gear engagement of 1, 3 & 5th gear. Or you can replace the black boot with the newer white boot, GM P/N: 92169196.



**STEP 16.** Install top stick (L) using (2) 5/16-18 bolts and thread adhesive.

TOOL: 3/16 Hex and adhesive.

Torque bolts to 26 ft./lbs. (35 N/m)

**NOTE: FAILURE TO USE THREAD ADHESIVE COULD RESULT IN SHIFTER MALFUNCTION.**



**STEP 17. OPTIONAL:** For more self-centering action, you can add the (2) springs (B) .  
TOOL: 5/32 Hex & thread adhesive.  
Torque bolts to 13 ft./lbs. (17 N/m)  
**NOTE: FAILURE TO USE THREAD ADHESIVE COULD RESULT IN SHIFTER MALFUNCTION.**

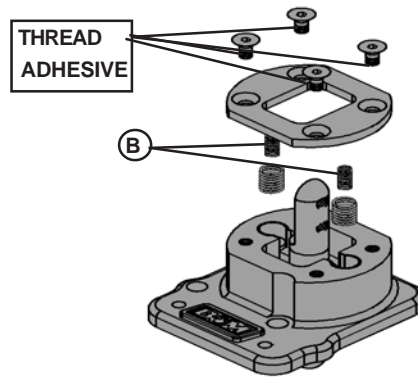

**STEP 18.** Reinstall nuts (4) holding down rubber boot.  
TOOLS: 13mm socket, Extension, Drive & 13mm wrench..



**STEP 19.** Lower vehicle  
TOOLS: Jack, Jack stands (4)

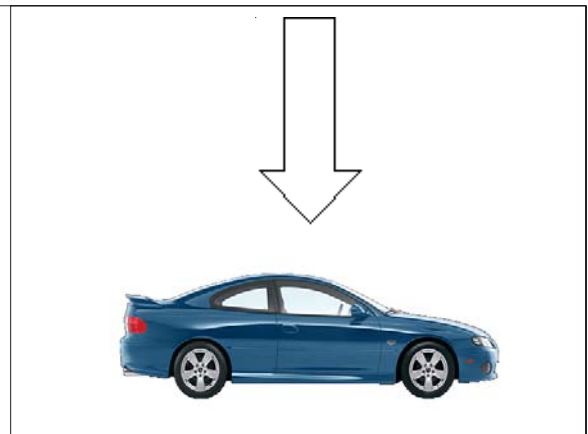

**STEP 20.** Install shift knob and boot by firmly pushing knob onto B&M shifter and snap boot back in.



**STEP 21.** Reinstall wires onto windows and T/C switches on center console.



**STEP 24.** Reinstall center console.



**STEP 25.** Reinstall screw for console.  
TOOLS: Screwdriver (phillips)



**STEP 26.** Be sure all the parts have been securely tightened and shifter engages into each gear.





# **INSTRUCTION ADDENDUM FOR ALL TREMEC TRANSMISSION SHIFTER APPLICATIONS**

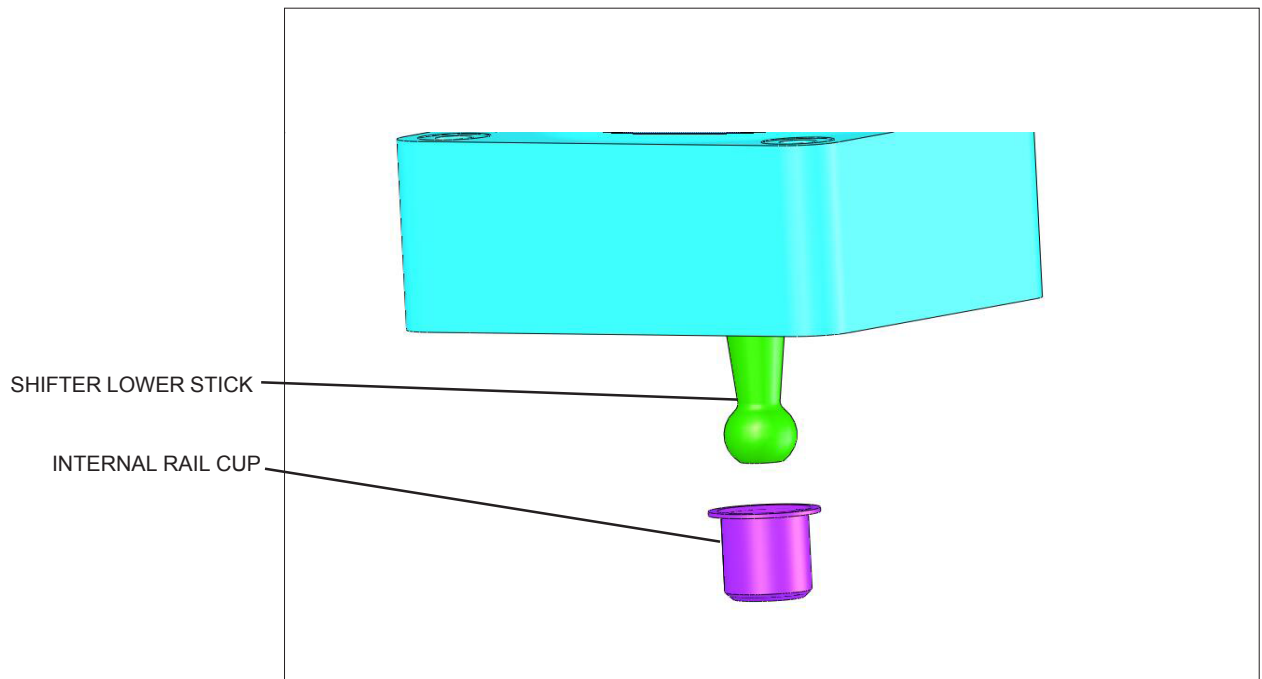

**INTERNAL RAIL CUP NOW SUPPLIED WITH TREMEC  
TRANSMISSION SHIFTER APPLICATIONS TO REPLACE  
POSSIBLE WORN INTERNAL RAIL CUP.**

**THIS CUP MAY BE WORN ON YOUR APPLICATION, PLEASE CHECK FOR LOOSENESS AND REPLACE AS  
NECESSARY.**

**INSTALL ON SHIFTER LOWER STICK AND INTO TRANSMISSION.**