



Equipped with AEM® Dryflow™ Filter
No Oil Required!

INSTALLATION INSTRUCTIONS

PART NUMBER:21-8009

1999-2003	CHEVROLET	S10 Pickup	L4-2.2L	C.A.R.B. E.O. # D-670-2
1998	CHEVROLET	S10 Pickup	L4-2.2L	SEE * NOTE
1998-2003	GMC	Sonoma	L4-2.2L	C.A.R.B. E.O. # D-670-2

*** NOTE: Legal in California only for racing vehicles which may never be used upon a highway**

PARTS LIST

Description	Qty.	Part Number
Air Filter Assy. 3.00 X 9" Dry Ele.	1	21-2039DK
Heat Shield	1	20-8009
Inlet Pipe	1	2-80091P
Elbow, 3.00/2.75 90 Deg.	1	5-492
Hose; 1/2"ID X 35"L	1	5-5035
Decal, Warning Fan Shroud	1	10-903
Mount, Rubber 1" X 8mm	1	1228560
Grommet, 1/2"	1	784634
Zip Tie, 6 Long	1	1-113
Washer, 8mm Soft Mount	1	559960
Nut, M8 Hex Serrated	1	444.460.08
1/2" Bnd. Hose Clamp, 2.31-3.25"	1	9444
1/2" Bnd. Hose Clamp, 2.56"-3.50"	1	9448
1/2" Bnd. Hose Clamp, 2.90"-3.75"	1	9452
Hose Clamp, 1"	2	08407

Read and understand these instructions **BEFORE** attempting to install this product. Failure to follow installation instructions and not using the provided hardware may damage the intake tube, throttle body and engine.

The AEM® intake system is a performance product that can be used safely during mild weather conditions. During harsh and inclement weather conditions, you must return your vehicle to stock OEM air box and intake tract configuration. Failure to follow these instructions will void your warranty.

1. Preparing Vehicle

- a. Make sure vehicle is parked on level surface.
- b. Set parking brake.
- c. If engine has run in the past two hours, let it cool down.
- d. Disconnect negative battery terminal.
- e. Do not discard stock components after removal of the factory system.

2. Removal of stock system

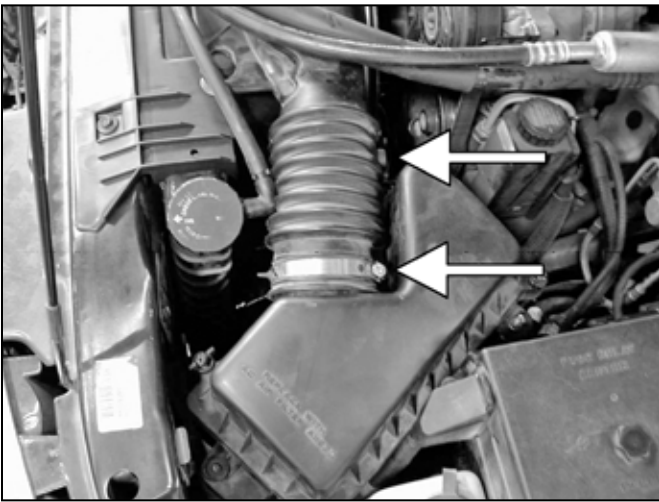

a. Loosen the hose clamp that secures the intake duct to the air cleaner housing. Remove the inlet air temperature (IAT) sensor from the intake duct. Set the IAT sensor in a safe place.

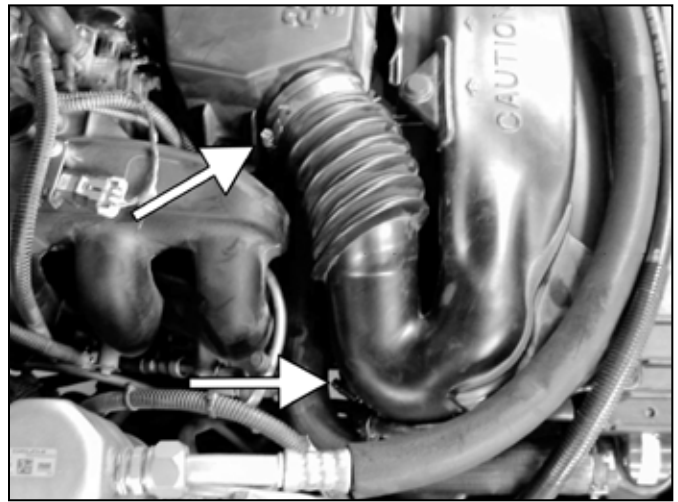

b. Loosen the two hose clamps securing the intake duct to the air box on top of the motor and to the resonator next to the radiator fan shroud.



c. Remove the two plastic rivets securing the intake duct in place. These two rivets are located under the air conditioning lines. Remove the intake duct from the vehicle. Use care to avoid bending the A/C lines too far.



d. Remove the resonator from the engine bay. Use care to avoid damaging the radiator hoses and the A/C lines.



e. Remove the mounting bolt that secures the air box to the intake manifold. Loosen the hose clamp securing the air box the throttle body.

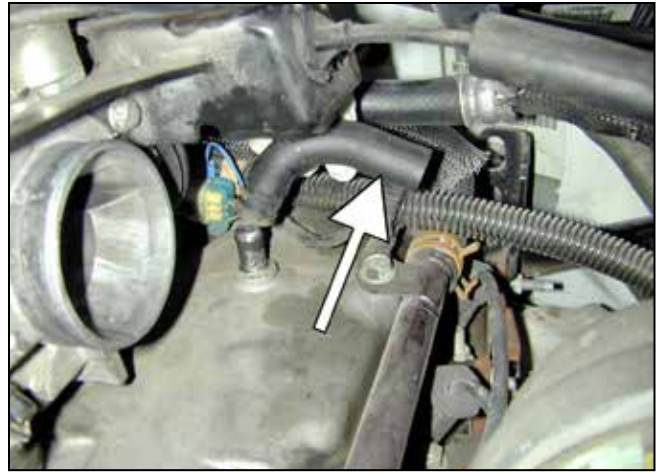

f. Rotate the air box up to gain access to the breather hose near the back. Remove the breather hose from the air box and remove the air box from the vehicle. Remove the breather hose from the valve cover by loosening the clamp.

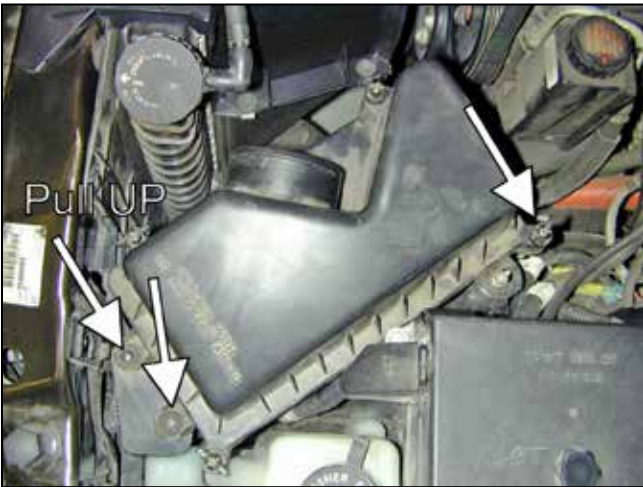

g. Remove the air cleaner housing by removing the retaining nut and pulling straight up on the rubber mounts at the radiator support.



h. Remove the plastic air box mounting bracket located next to the radiator. The bracket is released by sliding it straight up.



i. Remove the air cleaner housing mounting-stud. This stud will be replaced with the supplied rubber mount.

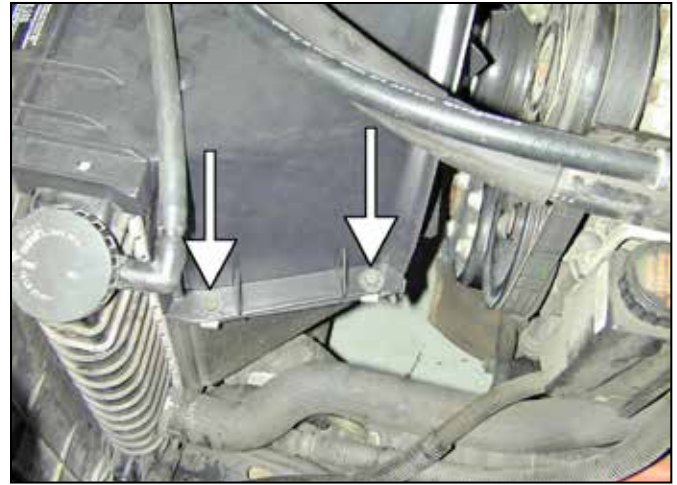

j. Remove the four radiator fan shroud mounting bolts (two on each side).



k. Remove the three radiator fan shroud mounting bolts along the top edge of the radiator support. Remove the shroud from the engine bay. Maneuver the shroud carefully to avoid bending the fan blades, A/C lines or radiator fins.

3. Installation of AEM® intake system.

a. When installing the intake system, do not completely tighten the hose clamps or mounting hardware until instructed to do so.

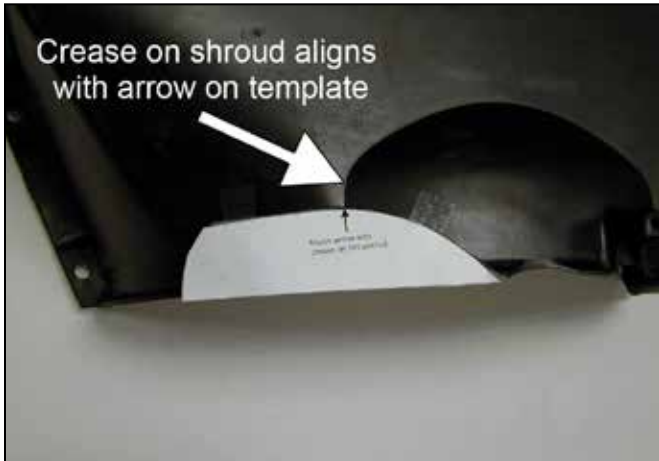

b. Cut-out the attached template at the end of these instructions. Tape the template in place on the radiator fan shroud. Be sure to align the arrow on the template with the crease on the shroud and the straight edge of the template with the edge of the shroud.



c. Using a hacksaw or other appropriate tool, trim the radiator fan shroud, using the paper template as a guide. It is better to remove too little at first then to remove too much. You can always go back and trim more off if necessary after test fitting.



d. Reinstall the radiator fan shroud, being careful not to bend the fan blades, A/C lines, or radiator fins. Secure with the three bolts along the top of the support and the two on the passenger side of the vehicle. Leave the two on the driver's side out until instructed to install them in the next step.



e. Align the two tabs on the AEM® heat shield with the two radiator fan shroud holes. Install the original bolts to hold the heat shield in place.

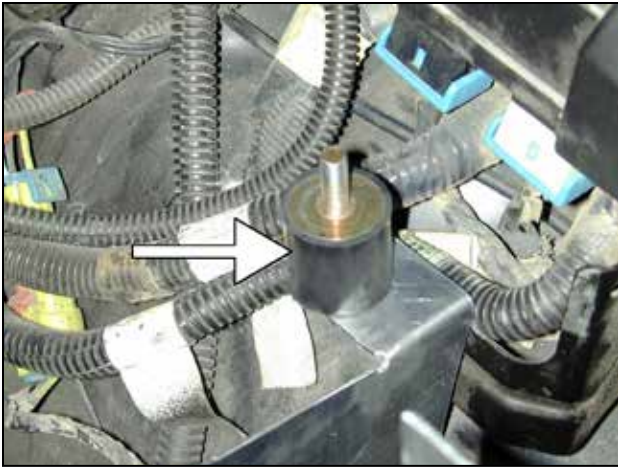

f. The third tab on the heat shield should line up with the hole where the air cleaner mounting stud was removed. Secure the heat shield with the supplied rubber mount.



g. Install the supplied breather hose on to the valve cover and secure with the 1" hose clamp. Route the hose around the back of the oil dipstick, being careful not to kink the hose.



h. Loosely install the 2.75" to 3.00" 90-degree coupler on to the throttle body. The 2.75" end and #44 hose clamp attach to the throttle body, the 3.00" end and #48 hose clamp face the front of the vehicle.



i. Install the supplied IAT grommet in to the backside of the AEM® inlet pipe.



j. Place the AEM® air filter in the well created by the heat shield. Orient the hose clamp so that it is easy to get to for tightening.



k. Feed the throttle body end of the inlet pipe (the end furthest from the IAT grommet and bracket) under the A/C lines and into the coupler installed in step 3h. Loosely secure with the #48 hose clamp.



l. Loosely install the AEM® air filter on to the end of the inlet pipe.



m. The bracket on the pipe will line up with the rubber mount installed in step 3f. Loosely secure the bracket with the supplied M8 washer and locknut. Refer to the following diagram for proper rubber mount installation.

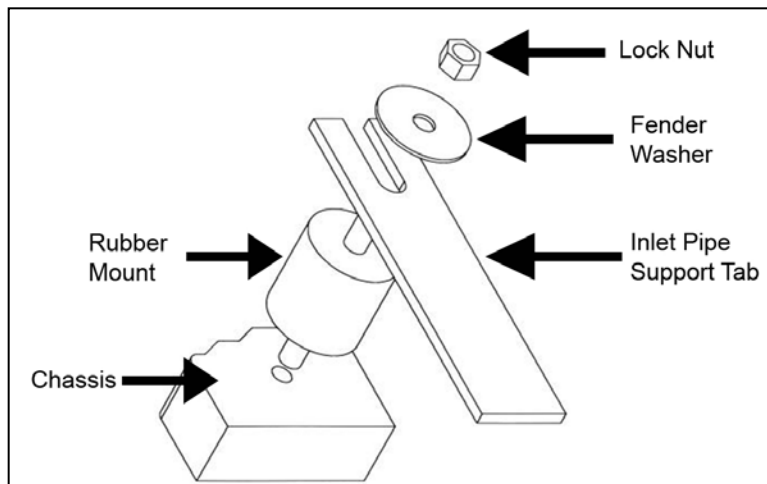

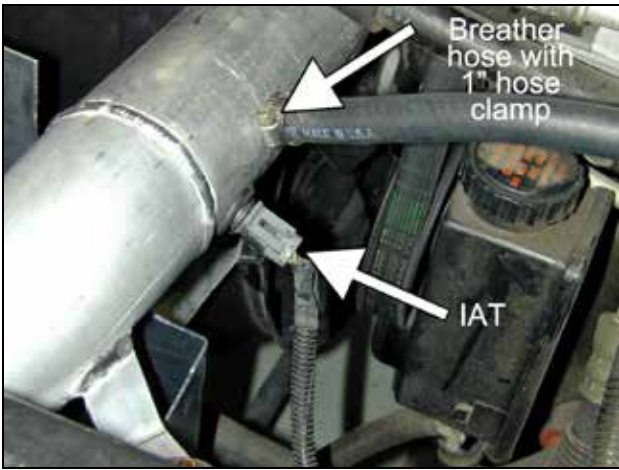

n. Lightly lubricate the IAT grommet using clean engine oil. Insert the IAT sensor into the grommet, using care to avoid pushing the grommet through into the inlet pipe. Connect the open end of the breather hose to the nipple on the inlet pipe. Secure with the remaining 1" hose clamp. Make sure the hose is not kinked anywhere along its path.

o. Use the supplied 6" plastic zip tie to secure the two A/C hoses together. Make sure the hoses do not come into contact with the AEM® inlet pipe. It may be necessary to gently bend the upper A/C line to prevent the lines from making contact with the intake system.



Factory air box system installed

AEM® intake system installed

4. Reassemble Vehicle

- a. Position the inlet pipes for the best fitment. Be sure that the pipes or any other components do not contact any part of the vehicle. Tighten the rubber mount, all bolts, and hose clamps.
- b. Check for proper hood clearance. Re-adjust pipes if necessary and re-tighten them.
- c. Inspect the engine bay for any loose tools and check that all fasteners that were moved or removed are properly tightened.
- d. Reconnect negative battery terminals and start engine. Let the vehicle idle for 3 minutes. Perform a final inspection before driving the vehicle.

5. CARB Sticker Placement

- a. The C.A.R.B. exemption sticker, (attached), must be visible under the hood so that an emissions inspector can see it when the vehicle is required to be tested for emissions. California requires testing every two years, other states may vary.
- b. Most General Motors trucks (including Chevrolet) have the Vehicle Emissions Certification Information (VECI) label affixed to the air filter box. In order to be compliant with California emissions laws, the label MUST remain in the engine compartment. If the Vehicle Emission Control Information label is removed during modification, a new replacement label must be obtained and installed in a readily visible position in the engine compartment. The label shall not be affixed to any equipment which is easily detached from the vehicle. We recommend that the label is affixed to the underside of the hood adjacent to the hood latch. The label is Vehicle Identification Number dependent and can be ordered from the vehicle dealership. In order to receive the proper decal please bring your VIN with you. Failure to have the VECI under the hood may result in failure of a pre-registration smog test.

6. Service and Maintenance

- a. It is recommended that you service your AEM® Dryflow™ filter every 20,000 miles for optimum performance. Use AEM Dryflow cleaning kit part # 21-110.
- b. Use aluminum polish to clean your polished AEM® intake tube.
- c. Use window cleaner to clean your powder coated AEM® intake tube. **(NOTE: DO NOT USE aluminum polish on powder coated AEM intake tubes).**

For technical inquiries
e-mail us at
sales@aemintakes.com
or
call us at
800.992.3000

AEM Air Intake System Warranty Policy

AEM® warrants that its intake systems will last for the life of your vehicle. AEM will not honor this warranty due to mechanical damage (i.e. improper installation or fitment), damage from misuse, accidents or flying debris. AEM will not warrant its powder coating if the finish has been cleaned with a hydrocarbon-based solvent. The powder coating should only be cleaned with a mild soap and water solution. Proof of purchase of both the vehicle and AEM intake system is required for redemption of a warranty claim.

This warranty is limited to the repair or replacement of the AEM part. In no event shall this warranty exceed the original purchase price of the AEM part nor shall AEM be responsible for special, incidental or consequential damages or cost incurred due to the failure of this product. Warranty claims to AEM must be transportation prepaid and accompanied with dated proof of purchase. This warranty applies only to the original purchaser of product and is nontransferable. Improper use or installation, use for racing, accident, abuse, unauthorized repairs or alterations voids this warranty. AEM disclaims any liability for consequential damages due to breach of any written or implied warranty on all products manufactured by AEM. Warranty returns will only be accepted by AEM when accompanied by a valid Return Merchandise Authorization (RMA) number. Credit for defective products will be issued pending inspection. Product must be received by AEM within 30 days of the date RMA is issued.

If you have a warranty issue, please call (800) 992-3000 and our customer service department will assist you. A proof of purchase is required for all AEM warranty claims.

