



## Installation Instructions Transpak

Fits: 1978-1996 Chrysler, Dodge, Plymouth  
See Application Guide for Specific Transmission Sizes  
Catalog # 10227

**WORK SAFELY!** For maximum safety, perform this installation on a clean, level surface and with the engine turned off. Place blocks or wedges in front of and behind both rear wheels to prevent movement in either direction.

**CAUTION:** To avoid any possibility of bodily injury or damage to vehicle, do not attempt installation until you are confident that the vehicle is safely secured and will not move.

The 10227 Transpak fits all three and four speed (overdrive) transmissions made between 1978½ and 1996. These are A-904, A-998, A-999 and A-727 three speed transmissions and A-500 and A-518 four speed (Overdrive) transmissions. These transmissions are also referred to as TC6, TF6, TF8, 42-44-45-46-47 RH AND RE. All of these transmissions have lock-up torque converters.

**NOTE:** The Transpak is not a cure-all for an ailing transmission. If your transmission is slipping or in poor general shape, the installation of a Transpak Kit may worsen the condition. However, on a properly operating transmission in average condition, the Shift Improver Kit will provide the kind of transmission performance you're looking for.

### INTRODUCTION

**NOTE:** Transmission components and valves are precision fit parts. Burrs and dirt are the number one enemies of an automatic transmission. Cleanliness is very important, so a clean work area or bench is necessary. We suggest a clean work bench top from which oil can easily be cleaned or a large piece of cardboard.

This kit contains all parts necessary to obtain three levels of performance depending on intended use:  
**Heavy Duty:** For towing, campers, motorhomes, police, taxi, etc. Firm shift feel without loss of driver comfort.

**Street/Strip:** Street driven hi-performance cars, extra firm shift feel, minor loss of driver comfort.

**Off-Road Racing:** High performance vehicles on loose surfaces where full manual control of shifting is desired. Optional feature for 3 speed transmission only (NOTE: complete ALL steps that indicate "FOR 3-SPEED OFF ROAD RACING APPLICATIONS ONLY").

## DISASSEMBLY

1. Drain and remove the transmission oil pan. If you do not have a drain plug, you should consider installing a B&M pan Drain Plug Kit, #80250, at this time. Remove the valve body (See Figure 1).

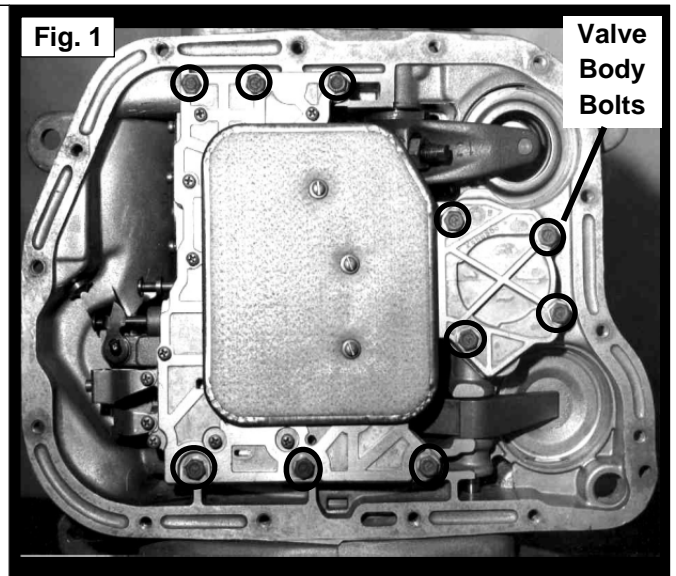

2. Remove and discard the filter. Carefully disassemble the valve body and lay out all the springs and valves as removed on a clean rag or paper towel (See Figure 2). Thoroughly clean each part (brake cleaner works well). Replace the stock limit valve spring with the supplied B&M limit valve spring (See Figure 2).

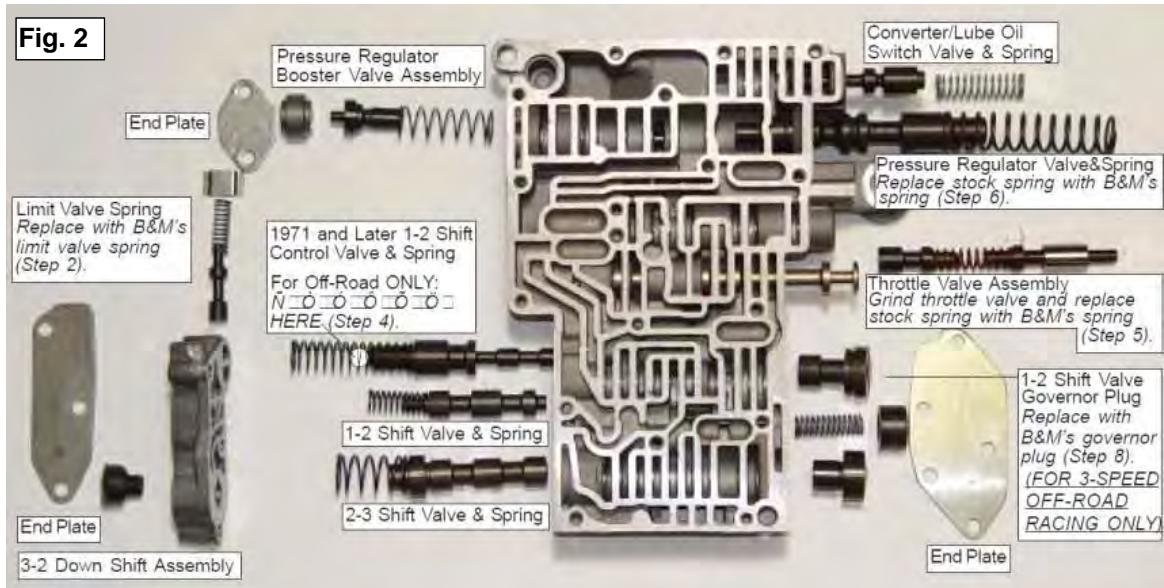

3. Install the supplied B&M drill guide as shown in figure 3. Wrap masking tape 3/8" above the tip of the supplied 3/16" diameter drill to use as a drill guide stop. Then drill through the hole in the guide keeping in mind the casting wall will be removed; but DO NOT drill through the valve body. If the indicated passage has a restrictor, drill the passage clear with the supplied #32 (.116 diameter) drill (See Figure 3).

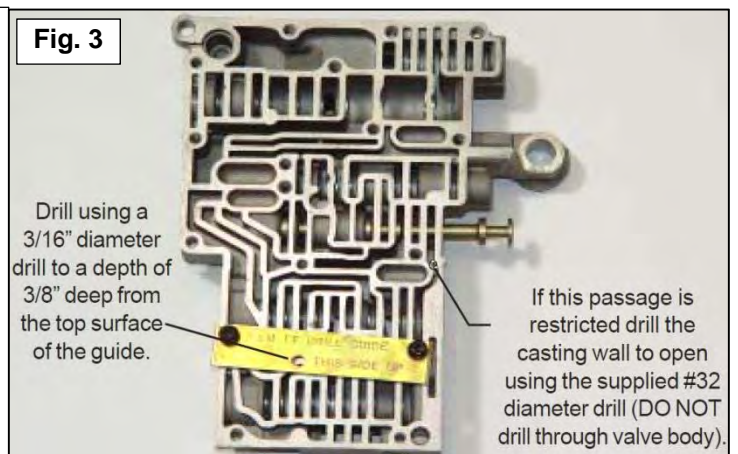

4. Referring to figure 2, reinstall the 2-3 shift valve and spring and the 1-2 shift valve and spring. Reinstall the 1-2 shift control valve and spring. For 3-SPEED OFF-ROAD RACING APPLICATIONS ONLY install the supplied B&M 1/4" check ball inside the spring on top of the 1-2 shift control valve. DO NOT install the 1/4" check ball in Heavy Duty and Street applications. Make sure all the valves and springs move freely, then install the down shift assembly and end plate. Reinstall the booster assembly (some early models do not have a spring), booster valve, sleeve, and end plate.

5. Modify the throttle valve as indicated in Figure 4 and install the into the valve body (See Figure 2).

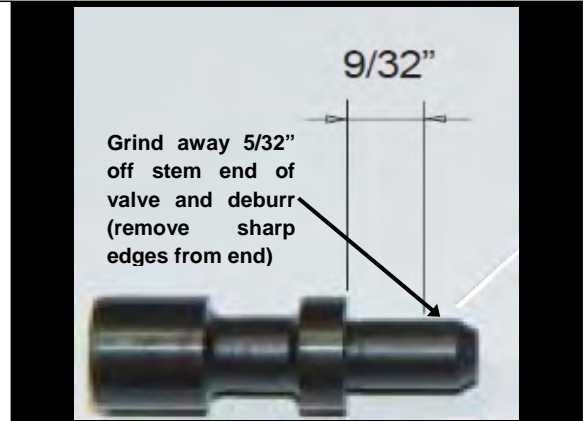

6. Reinstall the Pressure Regulator Valve using the supplied B&M Pressure Regulator Spring (See Figure 2).

7. Reinstall the original converter/lube oil switch valve and spring then set the valve body aside.

8. FOR 3-SPEED OFFROAD RACING APPLICATIONS ONLY: Replace the 1-2 shift governor plug with B&M's governor plug (See Figure 2).

9. Drill the separator plate as shown here in figure 5.

**Fig. 5**

HEAVY DUTY	STREET PERFORMANCE	3-SPEED OFF-ROAD RACING
(A) #32 (.116")	(A) 1/8" (.125")	(A) DO NOT drill
(B) 1/8" (.125")	(B) 3/16" (.1875")	(B) 3/16" (.1875")
(C) 3/16" (.1875") Jeep do not drill	(C) 3/16" (.1875") Jeep do not drill	(C) 3/16" (.1875") Jeep do not drill
(D) 5/32" (.156") Jeep do not drill	(D) 5/32" (.156") Jeep do not drill	(D) 5/32" (.156")
(E) 5/32" (.156") If triangular do not drill	(E) 5/32" (.156") If triangular do not drill	(E) 5/32" (.156") If triangular do not drill

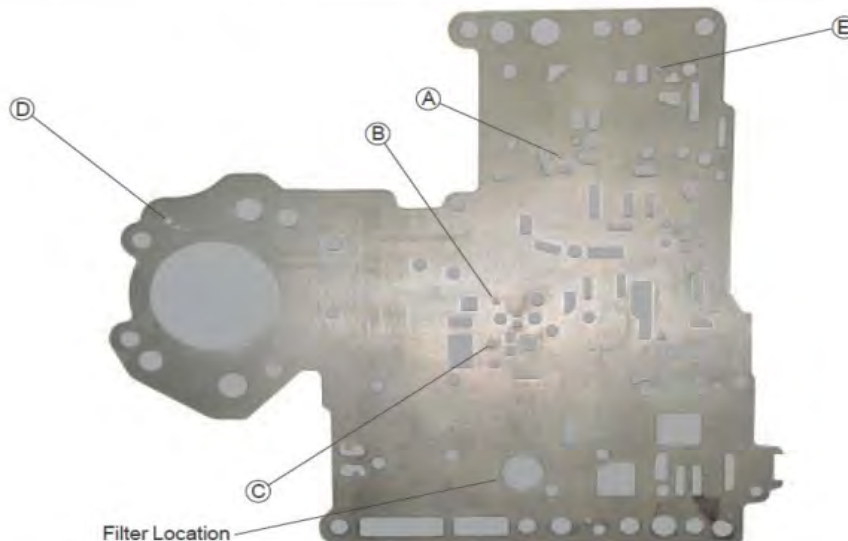

10. 4 Speeds ONLY: Install the piston as removed (See Figure 6) with the non-hollow end into the bore, replacing the original spring with the supplied B&M 3-4 accumulator spring. Install the B&M aluminum cup orifice plug in the location shown in Figure 6 below the deck surface.

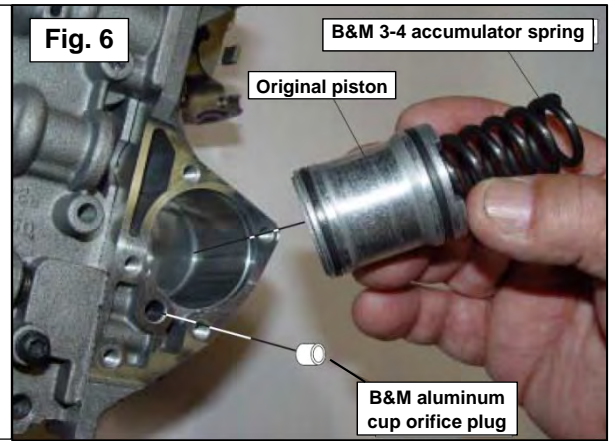

11. Remove check balls from the check ball location #1 and check ball location #2 from the transfer plate (See Figure 7).

EXCEPTION FOR JEEPS: DO NOT remove check ball from check ball location #2.

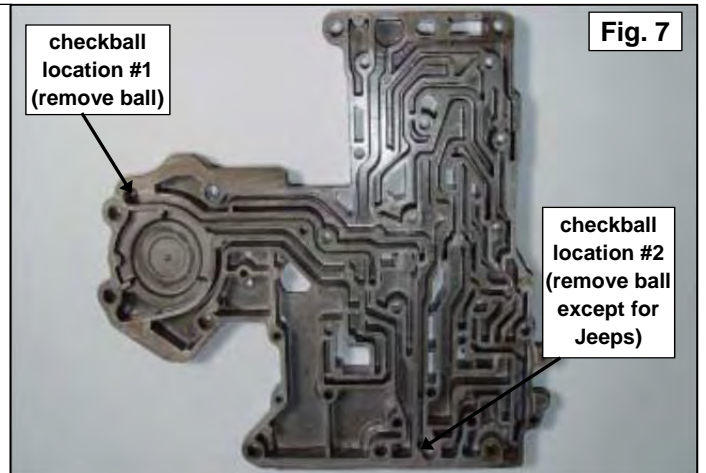

12. Referring to Figure 8, make sure all indicated checkballs are of the proper size and location as indicated.

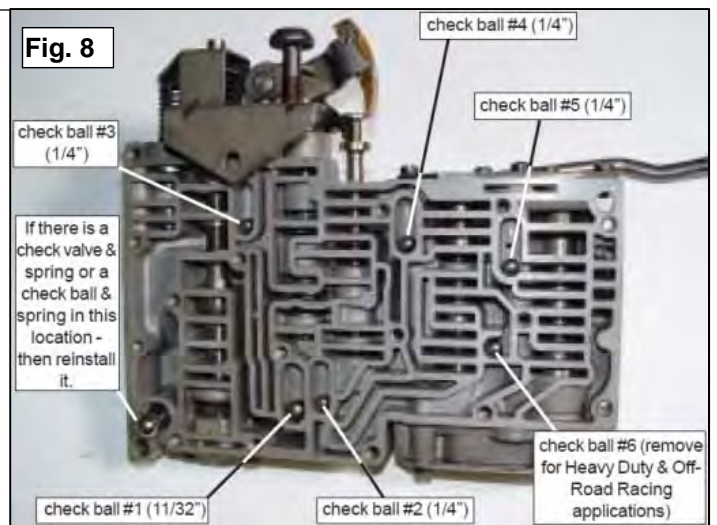

13. Reassemble the separator plate onto the transfer plate as shown in figure 9.

**NOTE:** Figure 9 shows the 1970 and later model stiffener plate, other year model stiffener plates may vary in appearance.

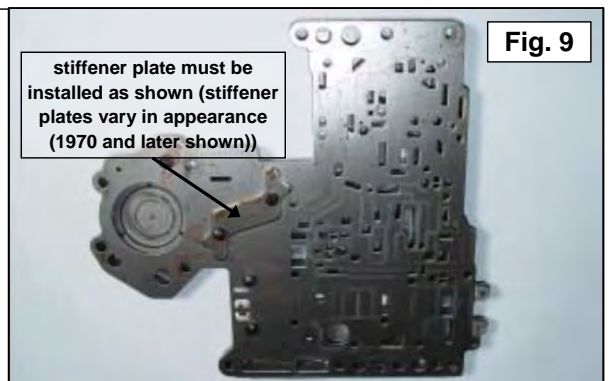

14. Use a 3/16" Allen wrench and turn the adjustment screw (See Figure 10) clockwise until the pressure regulator spring seat is sitting flush against the inside edge of the spring retainer. Then turn the adjustment screw five (5) full turns counterclockwise for heavy duty applications or seven (7) full turns for street level and 3-speed off-road racing applications.

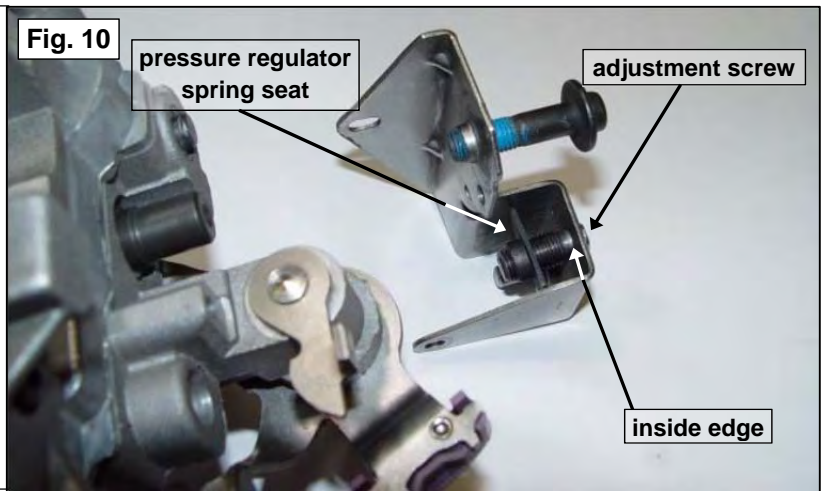

15. Remove 2nd gear accumulator spring (See Figure 11) and discard. 727 CASE ONLY: install steel orifice plug just below the surface in the indicated hole, using a flat nose punch.

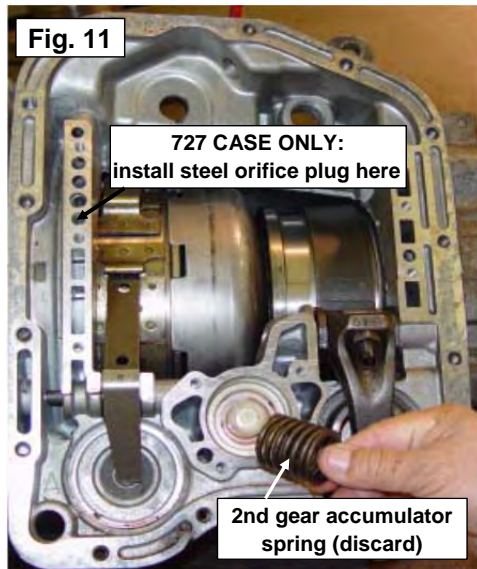

16. Install the B&M blocker rod as shown below (See Figure 12):

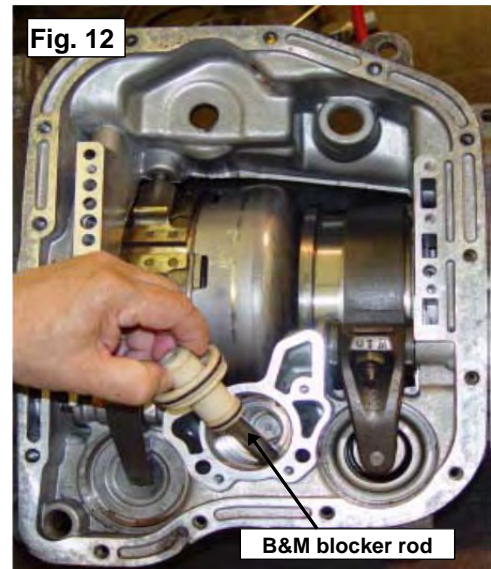

17. FOR 3-SPEED OFFROAD RACING APPLICATIONS ONLY  
(Manual down shifts to low gear at any speed)  
**!!NOT RECOMMENDED FOR STREET USE!!-**

**NOTE:** This step may require the assistance of a professional transmission mechanic. Loosen the rear servo band lock nut and back the adjuster all the way out. Move the extension housing back far enough to pull the band anchor out (See Figure 13). When the apply arm is loose the band strut will fall out and the apply arm will be able to move out of the way to access the rear servo.

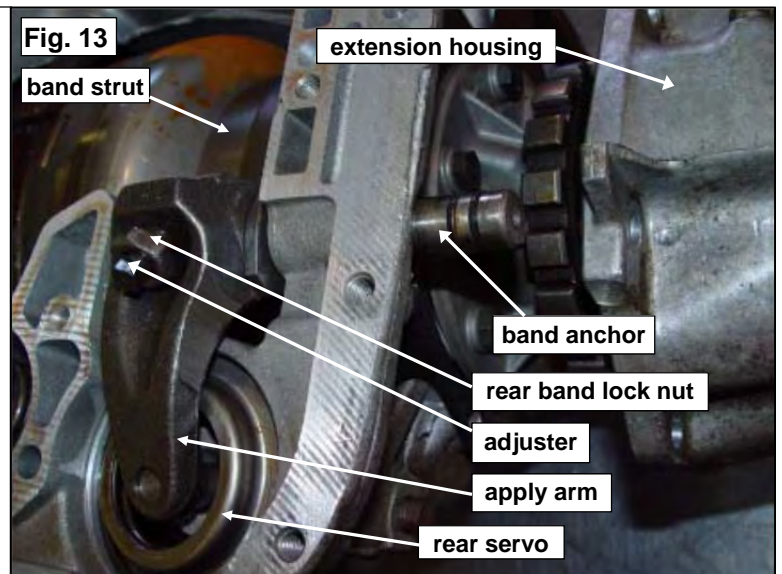

18. FOR 3-SPEED OFF-ROAD RACING APPLICATIONS ONLY  
(Manual down shifts to low gear at any speed)  
**-!!NOT RECOMMENDED FOR STREET USE!!-**

Push down on the spring retainer and remove the internal retaining ring. Take the spring retainer, original servo spring, and piston assembly out of the bore (See Figure 14).

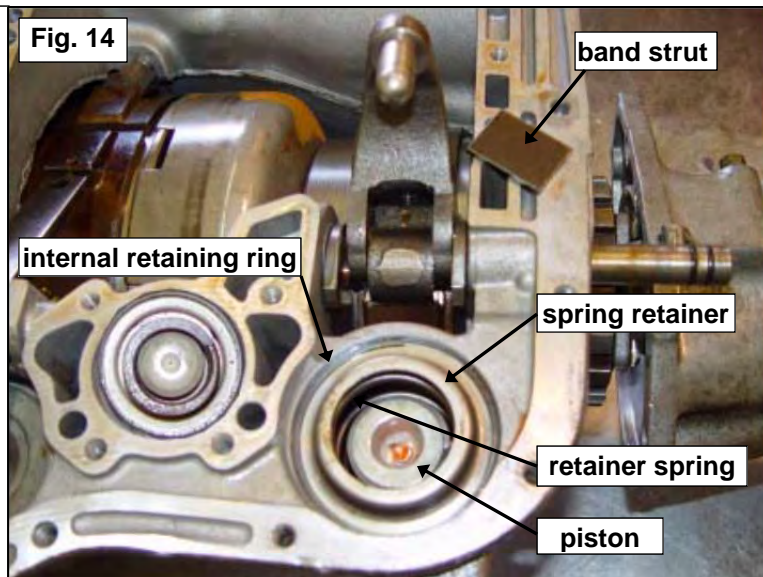

19. FOR 3-SPEED OFF-ROAD RACING APPLICATIONS ONLY  
(Manual down shifts to low gear at any speed)  
**-!!NOT RECOMMENDED FOR STREET USE!!-**

Push down on the rear servo piston assembly and remove the external retaining ring (See Figure 15).

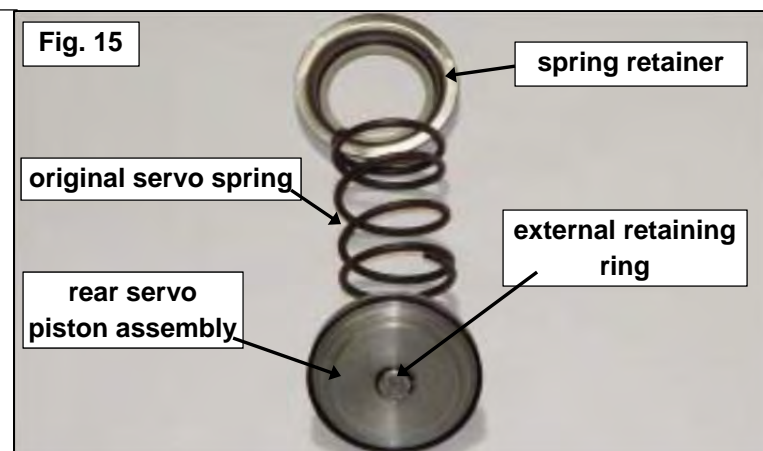

20. FOR 3-SPEED OFF-ROAD RACING APPLICATIONS ONLY  
(Manual down shifts to low gear at any speed)  
**-!!NOT RECOMMENDED FOR STREET USE!!-**

Install the supplied B&M rear servo blocker as indicated in Figure 16. Reassemble the piston, the original piston spring, and the supplied external retaining ring (See Figure 16).

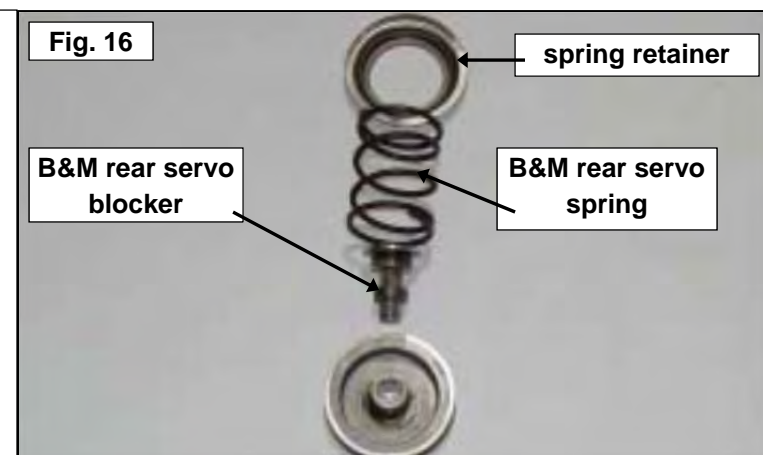

21. FOR 3-SPEED OFFROAD RACING APPLICATIONS ONLY - (Manual down shifts to low gear at any speed) -**!! NOT RECOMMENDED FOR STREET USE !!-**

Reinstall the modified rear servo piston assembly, supplied B&M rear servo spring, spring retainer and internal retaining ring back into the bore. Reassemble the band strut, band anchor, and extension housing. Tighten the adjuster until it is snug and then back the adjuster off three (3) full turns. Secure the adjuster with the rear band lock nut.

**22. (1966 thru 1969 transmissions only):**

Loosen the front servo adjusting screw, band anchor, and front and apply strut. Remove the front servo (See Figure 17).

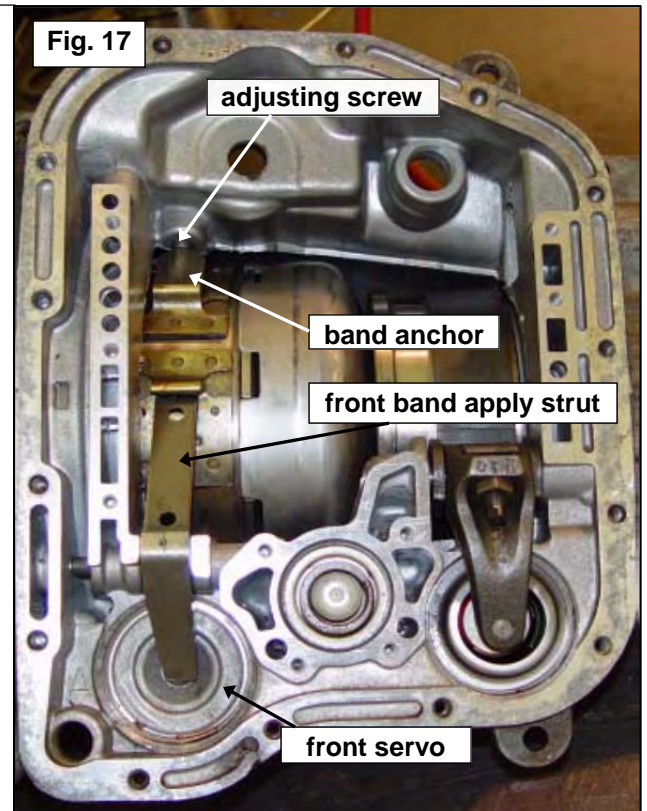

**23. (1966 thru 1969 transmissions only)**

Install the supplied B&M front servo inner return spring if not already equipped (later model transmissions do not require any front servo modification) (See Figure 18). The later model front servo piston has a larger (over 1/2") diameter center pin and does not require any disassembly or modification.

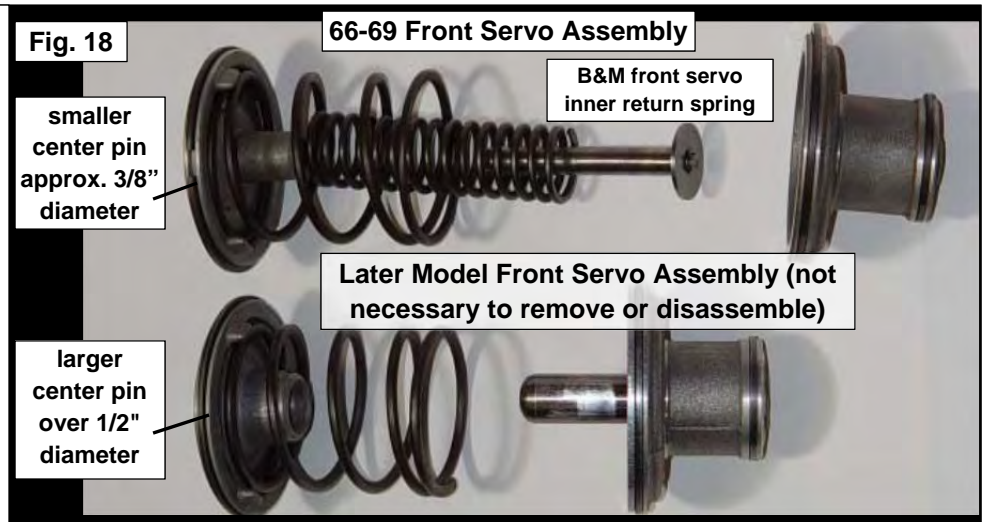

24. Reassemble in reverse order as disassembled.

## TROUBLE SHOOTING GUIDE

<u>Malfunction</u>	<u>Probable Cause</u>	<u>Malfunction</u>	<u>Probable Cause</u>
No movement	On 1978 and later - Reversed torque converter valve.	Leaks	Clean transmission first and observe, check pan gasket and bolt torque.
Slips	Low fluid level.	Will not upshift	Throttle pressure linkage adjusted too high. Shift valves burred and sticking, loose bolts 1/4" steel ball installed behind 1-2 shift valve instead of 1-2 shift control valve.
Overheating, foaming oil at dipstick or breather	High fluid level.  Clogged or blocked cooler.	Soft shifts under power	Throttle pressure linkage adjusted too high. Low fluid level. High fluid level. Pressure regulator.
Erratic Shifting	Throttle pressure link sloppy, loose or misadjusted. Shifter misadjusted. Low fluid level. High fluid level. Valve body bolts or end plates loose.	Engine revs on 2-3 shift	Check band adjustment. Remove cupped orifice plug.
Late Shifts	Throttle pressure linkage misadjusted. Kickdown detent sleeve installed backwards.		

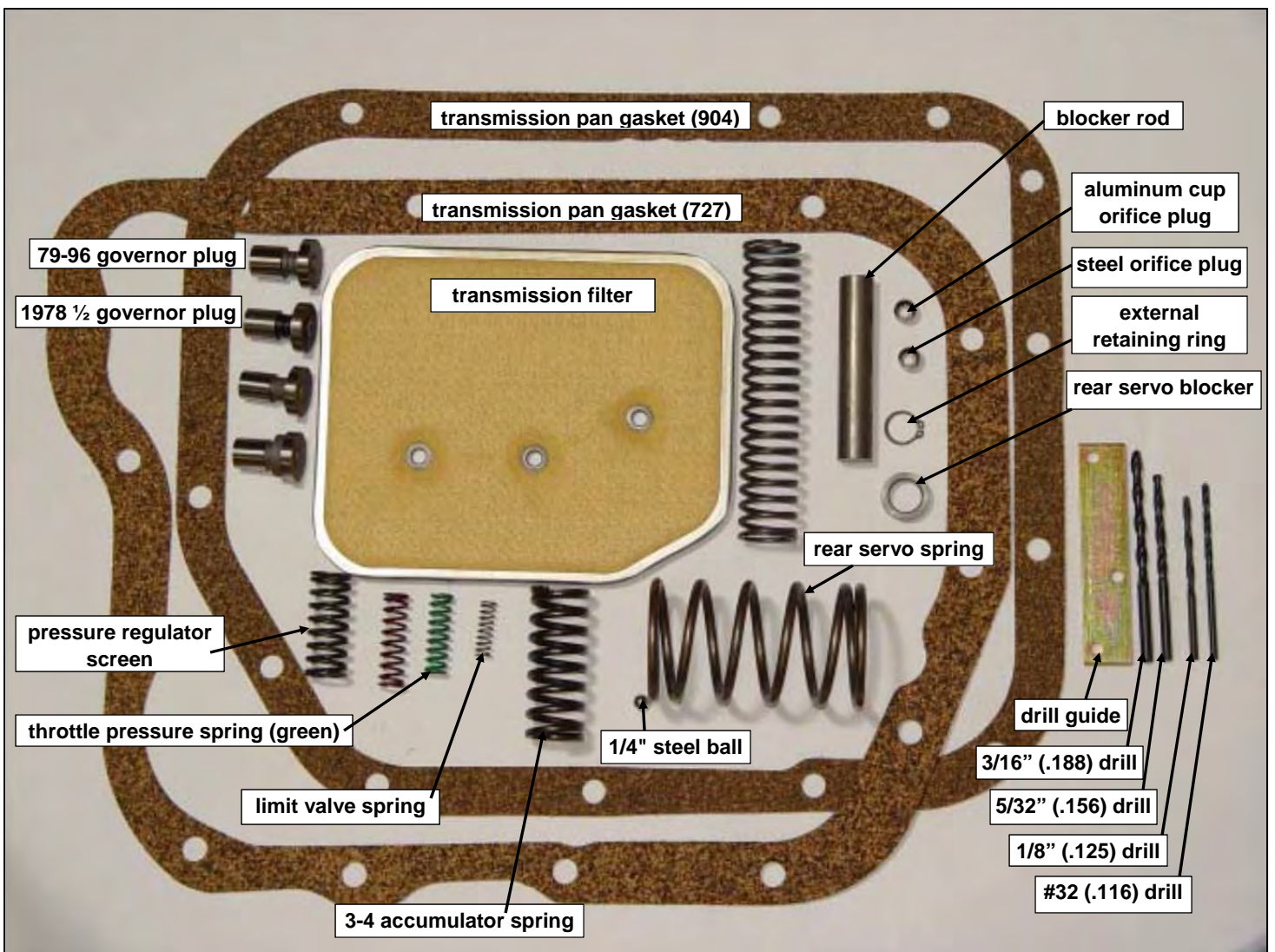



**IMPORTANT: RETAIN THESE INSTRUCTIONS FOR FUTURE REFERENCE**

**Technical Service**

A highly trained technical service department is maintained by Hurst Performance to answer your technical questions, provide additional product information and offer various recommendations.

Technical service calls, correspondence, and warranty questions should be directed to:



**B&M Racing & Performance Products**

(707) 544-4761

[www.bmracing.com](http://www.bmracing.com)