



Installation Instructions Street Bandit Shifter

Part Number 80797

(see www.bmracing.com for the latest technical product information)

©2006, 2000 by B&M Racing and Performance Products

The B&M Street Bandit Shifter is a gate pattern type shifter mechanism. It is available as a rear exit cable model only and it is designed for most three and four speed transmissions with standard pattern valve bodies. The B&M Street Bandit Shifter features a neutral safety switch and a reverse light switch as required for all street vehicles.

Please read the instructions and review the illustrations thoroughly before beginning the installation.

IMPORTANT: You must first install the shifter cable onto the shifter before positioning the shifter in your vehicle. This is to insure that you allow for proper clearance at rear of shifter before you permanently mount the shifter body into the vehicle. Mounting the shifter first without the cable attached can cause possible interference from interior components. Poor cable routing and cable binding will result in poor shifter operation or cable damage.

INSTALLING THE SHIFTER CABLE

STEP 1. Pull the shifter stick all the way back to the Low gear position. Remove the five countersunk screws from the shifter cover and remove the cover. Locate the cable attachment pin at rear of shifter stick. The pin is visible just under the black shift pattern gate

plate. Do not remove black gate plate (See Photo #1).

IMPORTANT: The three speed gate plate is assembled on the shifter mechanism by the B&M assembly technicians. If your transmission is a GM four speed, now is a good time to install the four speed gate plate. Please refer to page 8 for gate plate change instructions.

STEP 2. Fully extend the stamped

loop end of the shifter cable and insert it through the largest access hole in the rear of the shifter body. Slip the stamped loop cable end over the cable attachment pin at the rear of the shifter stick and attach the supplied e-clip to the pin. Check to make sure you have the e-clip firmly & accurately in the locating groove in the pin (See Photo #2).

STEP 3. Push the cable anchor tab

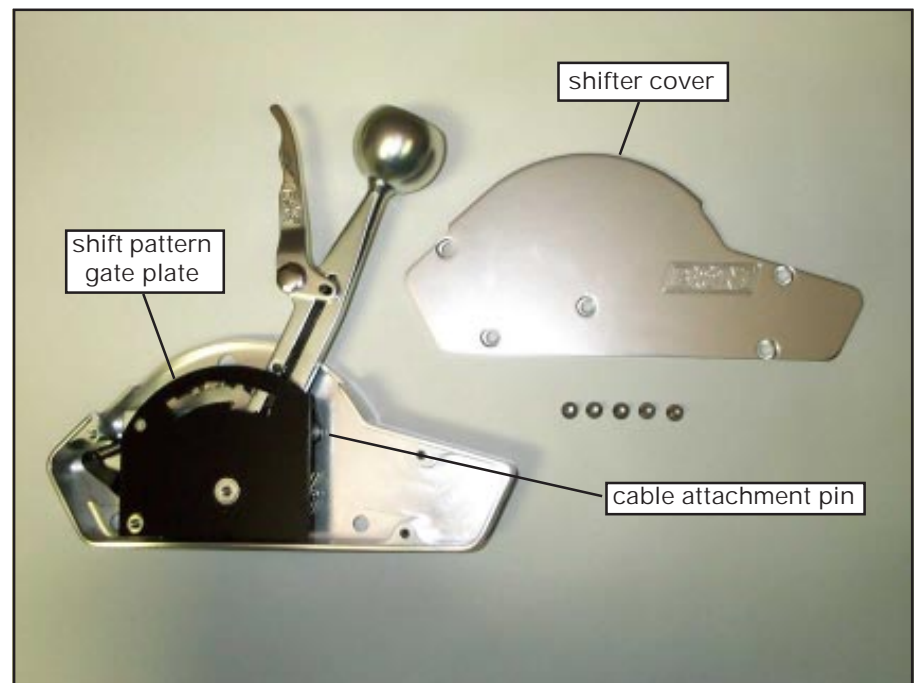

Photo #1

flush to the rear of the shifter body. Align the 17/64" cable flange hole with the 9/32" hole in the shifter body. Be sure to use the hole directly above the large cable access hole. Install the supplied 1/4" bolt from the outside of the shifter body through cable mounting flange until the bolt sticks through to the inside of the shifter body. Place the supplied 1/4" washer over the exposed threads on the inside, then thread on the 1/4" nut and tighten (See Photo #3).

STEP 4. Temporarily reinstall the side cover with the center screw only. This is to insure that the gate plate and the mechanism does not move from the inside of the shifter body. You are now ready to locate your B&M Street Bandit Shifter in your vehicle.

INSTALLING THE B&M STREET BANDIT SHIFTER INTO YOUR VEHICLE

STEP 5. With the driver sitting in the vehicle, find the best location that allows the driver full range of motion to easily work the shifter through the entire shift pattern, Park to Low gear. (Read the section on HOW TO OPERATE YOUR B&M STREET BANDIT SHIFTER). The two slotted holes at the bottom of the shifter body are designed for mounting tabs access from the supplied mounting bracket. The bracket tabs should slip up inside the slotted holes.

Be sure when choosing your shifter mounting location you route the shifter cable where it can be easily looped through the vehicle without binding or kinking. Most importantly, it is critical not to crush, bind or kink the shifter cable as it exits the rear of the shifter body. Poor cable routing will result in improper shifter operation and potential cable damage.

STEP 6. The B&M Street Bandit Shifter is designed to bring the cable to the transmission from the back of the transmission (See Figure #1). Install the mounting bracket in the vehicle (mounting holes of the bracket should be hidden underneath the shifter when in place) and tighten the bolts. (Figure #2 shows the dimension for

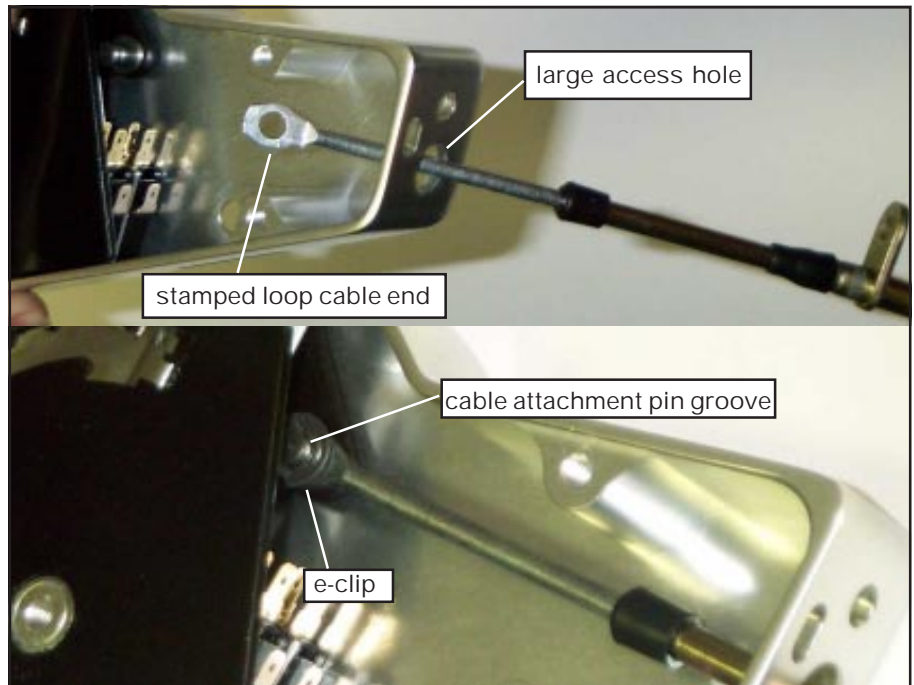

Photo #2

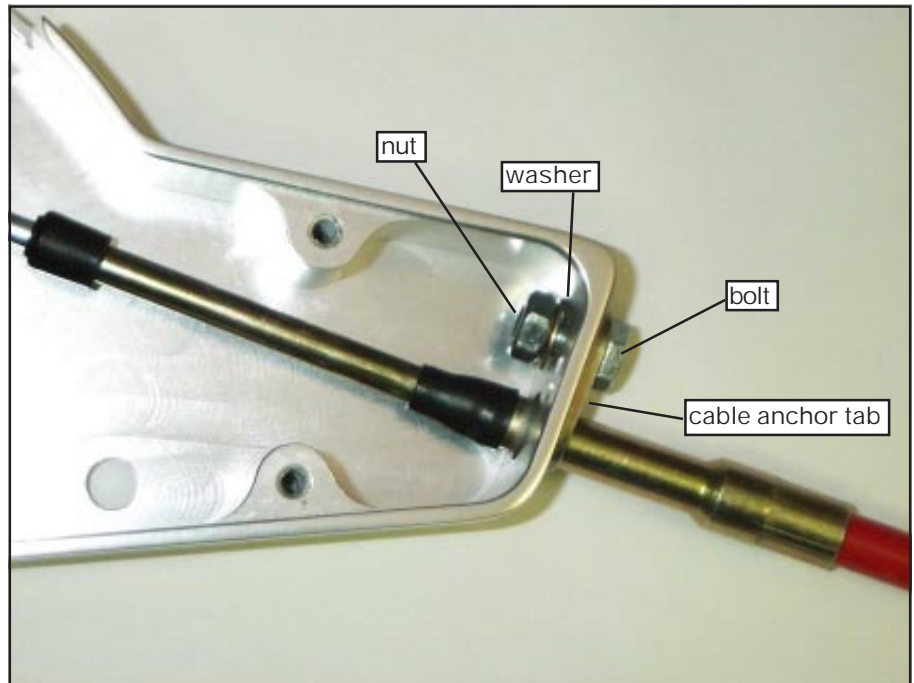

Photo #3

the mounting bracket holes). STEP 7. Carefully remove the single screw that is temporarily holding the cover in place. With the mounting bracket installed in the vehicle, slip the shifter body over the top of the tabs. Make sure that your tabs do not interfere with any of the internal mechanism components. STEP 8. Install the supplied 5/16" x 3/4" countersunk bolts through the countersunk mounting holes from the outside of the shifter body and through the holes in

the mounting bracket tabs. From inside of the shifter body, place the supplied 5/16" nyloc nuts onto the bolts and tighten. This will clamp the mounting bracket tabs to the shifter body. Be sure not to move the internal shifter mechanism or the gate plate while the cover is off. STEP 9. Reinstall the side cover with all five screws and tighten. Once the cover is installed check to make sure that the shifter operates

smoothly with no binding. If the shifter seems to bind check to make sure that the spring loaded detent lever did not get pulled out from inside the mechanism.

If for any reason the internal shifter mechanism becomes pulled off or away from the shifter body, make sure to check the spring loaded detent lever at the front of the mechanism. The best way to do this is to move the stick all the way back to the Low gear position. This will clear both switch detents away from the actuators. If they are aligned improperly you can easily break the switches. Apply light pressure to the black shift pattern gate plate while using needle nose pliers to rotate the spring loaded detent lever to the left. You will feel the detent locate itself back into position (See Figure #3 & Photo #4).

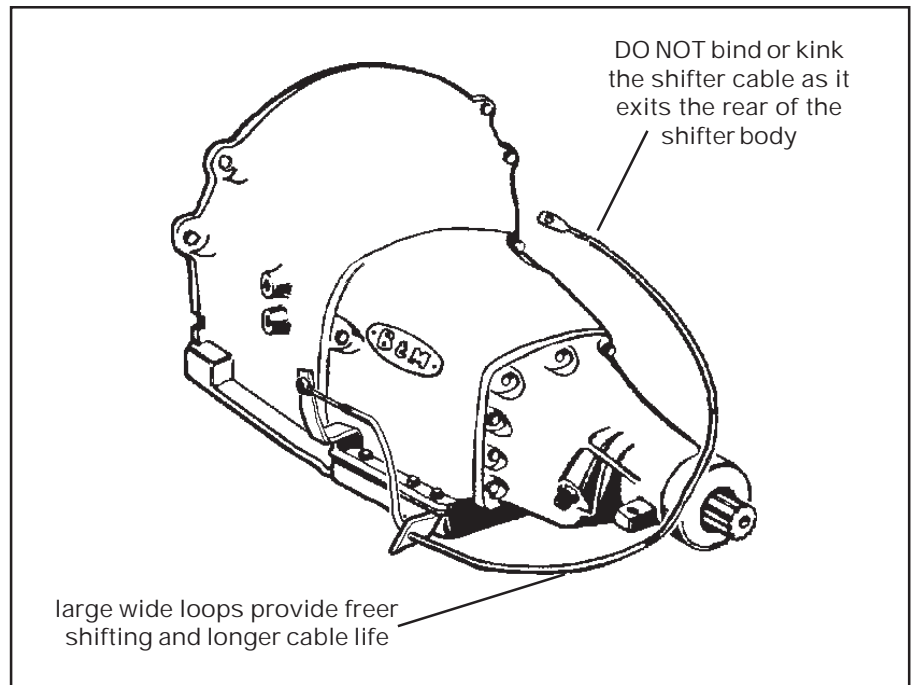

Figure #1

INSTALLING THE TRANSMISSION LEVER, BRACKET, NEUTRAL SAFETY SWITCH & REVERSE LIGHT SWITCH WIRES

GM Vehicles: go to Step 10
 Ford Vehicles: go to Step 18
 Chrysler Vehicles: go to Step 28

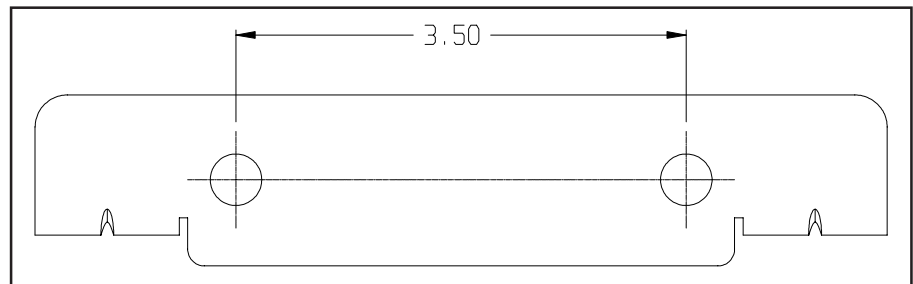

Figure #2

GENERALMOTORS

STEP 10. If you have not already done so, remove the stock selector lever nut and the selector lever from the transmission. Discard the stock lever and the stock shifter linkage. Install B&M's GM selector lever in position using the stock selector lever nut (See Photo #5). Torque nut to 23 lb.ft. The lever should move smoothly from front to rear with a positive click in each gear position.

STEP 11. Remove the two transmission oil pan bolts from the middle of the left side of the oil pan. Install the cable bracket in position (See Photo #5). The bracket must be installed with two spacers between the pan and the bracket (See Figure #4). (If your transmission is equipped with a cast aluminum oil pan, these spacers should be omitted however the cable bracket may have to be modified). Install the two supplied 5/16-18 x 1.00" bolts and

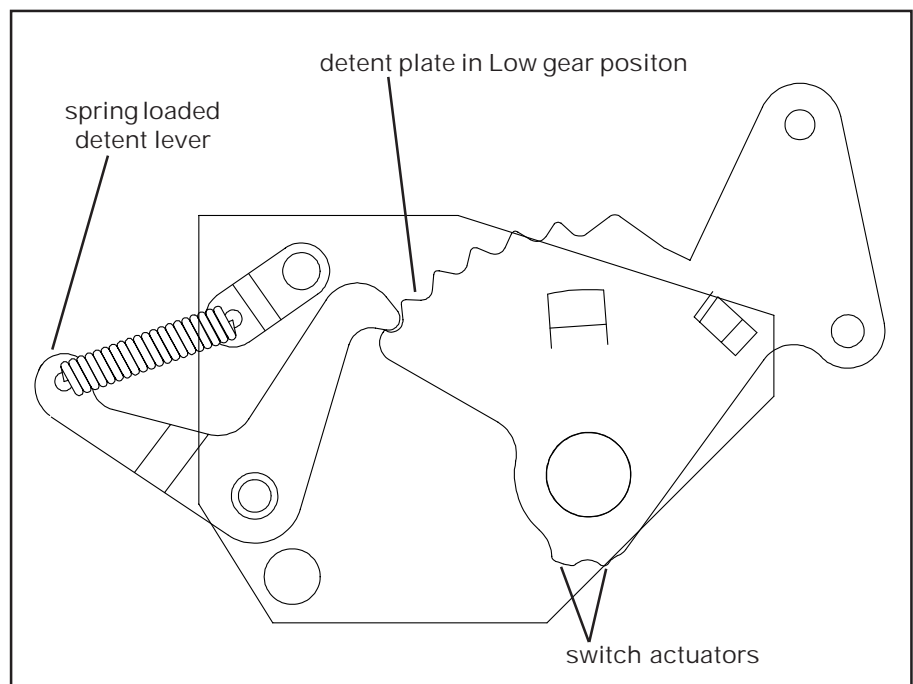

Figure #3

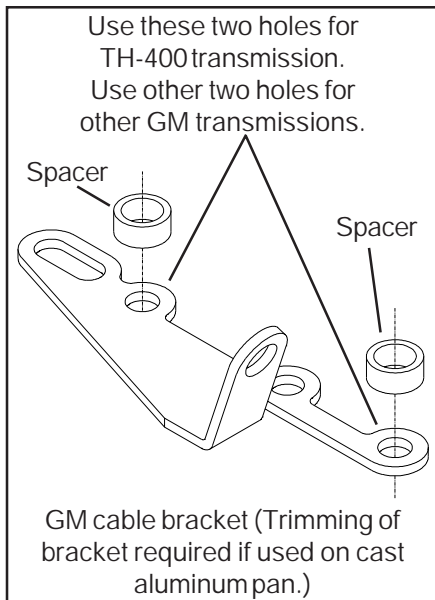

Figure #4

tighten 12-13 lb.ft. Do not overtighten as this can damage the pan gasket.

STEP 12. Route the shifter cable avoiding kinks and sharp bends, and route the cable away from hot engine or exhaust parts. Remove the two rubber boots, one large nut, and a large lockwasher from the threaded end of the shifter cable. Slide the end of the cable into the cable bracket. Install the large nut and the lockwasher loosely over the end of the cable. Install the two rubber boots onto the end of the cable. Install the swivel on the threaded end of the cable and position it in the center of the threaded portion (See Photo #5).

STEP 13. Move the transmission selector lever by hand to the full forward position (Low). Place the shifter lever to the Low gear position (all the way back). Adjust the large nuts on the cable so that the swivel will slide into the hole marked "R" on the selector lever. Tighten the large nuts completely. Be sure that the swivel will slide freely in and out of the hole in the selector lever. Note: The shifter will not operate correctly unless the hole marked "R" in the shift lever is used.

STEP 14. With the swivel in the selector lever, move the shifter to the Park position, all the way forward. The shift lever on the transmission should be all the way back. Check to see that the swivel will slide freely in and out of the hole in the lever in this position. If it does not slip in freely, adjust the swivel

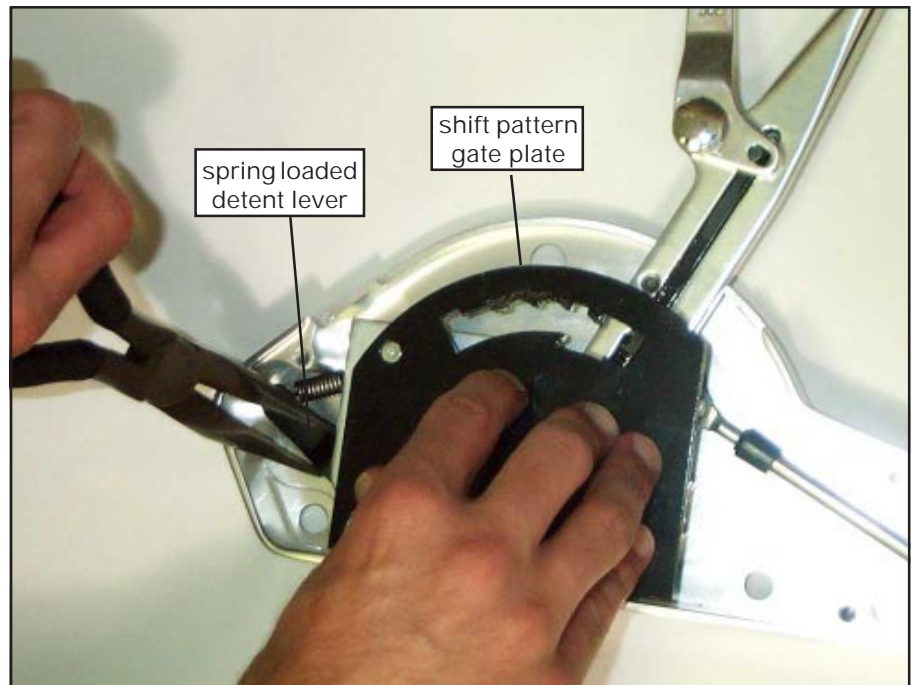

Photo #4

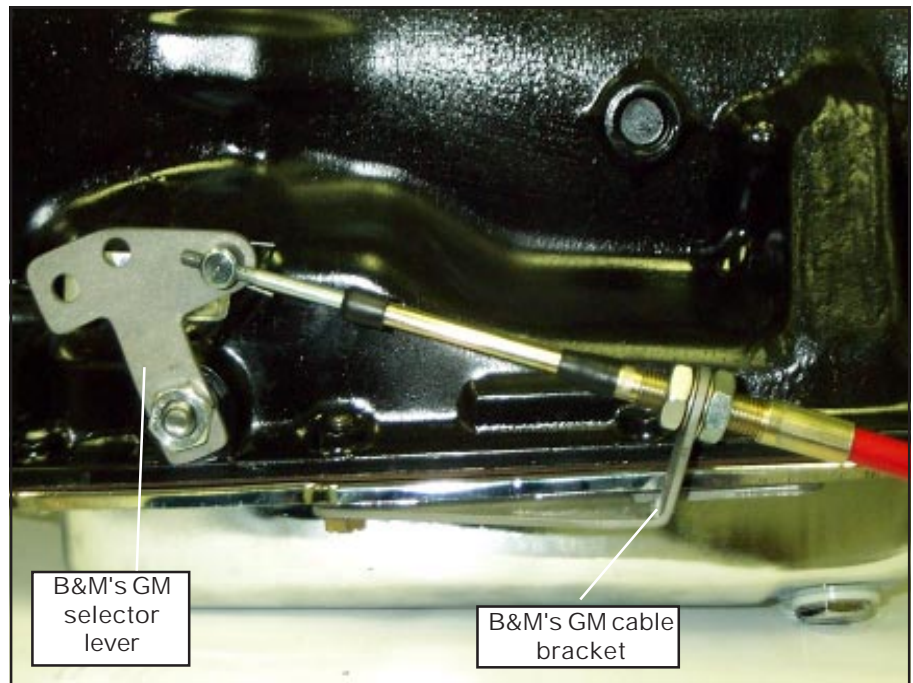

Photo #5

slightly until it will slip into the hole in the lever in both Low and Park positions. Operate the shifter through all the gear positions. Check to make sure the swivel will slide in and out of the selector lever hole in each gear position. Install the cotter key supplied with the shifter into the swivel and spread the key ends. If you have a problem, **DONOT FORCE THE SHIFTER**, this will damage the cable, the shifter or the transmission.

Simply start at the beginning and check all your steps.

STEP 15. The oval hole in the rear of the shifter body will serve as the exit for the two switch wires (See Photo #6). Since the neutral safety switch is a breaker that keeps the starter from engaging until the switch is closed in Neutral or Park, the color of the wires is not critical. It is only being used to break the 12V wire from the starter switch to the small wire on the starter

solenoid. The reverse light switch has the same function only that it breaks the power to the reverse lights. If your wiring is different, follow the instructions that pertain to your specific wiring layout.

STEP 16. On GM vehicles, the neutral safety switch may be located on the shifter (steering column or console), or it may be a mechanical interlock in the steering column that prevents the key from turning to the Start position unless the shifter is in the Park or the Neutral position. Identify the type of neutral safety system you have. If the key will not turn to the Start position unless the stock shifter is in Park or Neutral, you have a mechanical interlock, otherwise you have a neutral safety switch. With either type, disconnect the battery ground cable to prevent accidental shorts.

(A) If you have a neutral safety switch, locate and identify the neutral safety wires (engine will not crank unless these wires are connected together). Extend the wires from the GM switch to the shifter. Strip a ¼" of insulation off the wires and install the slip-on terminals supplied in the kit. Crimp the terminals onto the wires using a crimping tool or pliers. Connect the neutral safety wires to the LOWER switch and the backup light wires to the UPPER switch (See Photo #6). Tape the terminal connections and all other connections to prevent shorts.

(B) If you have a mechanical interlock cut the wire that goes from the Start position on the ignition switch to the solenoid on the starter. This wire is usually a 10 or 12 gauge purple wire. Run wires from both ends of the cut wire to the shifter. Put the slip-on terminals on the ends of the lengthened wires. Crimp the terminals onto the wires using a crimping tool or pliers. Connect the wires to the LOWER switch on the shifter. The backup light switch is usually located on the steering column behind the instrument panel. Lengthen these wires and run them to the UPPER switch on the shifter (See Photo #6). Tape the terminal connections and all other connections to prevent shorts.

STEP 17. Reconnect the battery ground cable, disconnect the coil wire and set

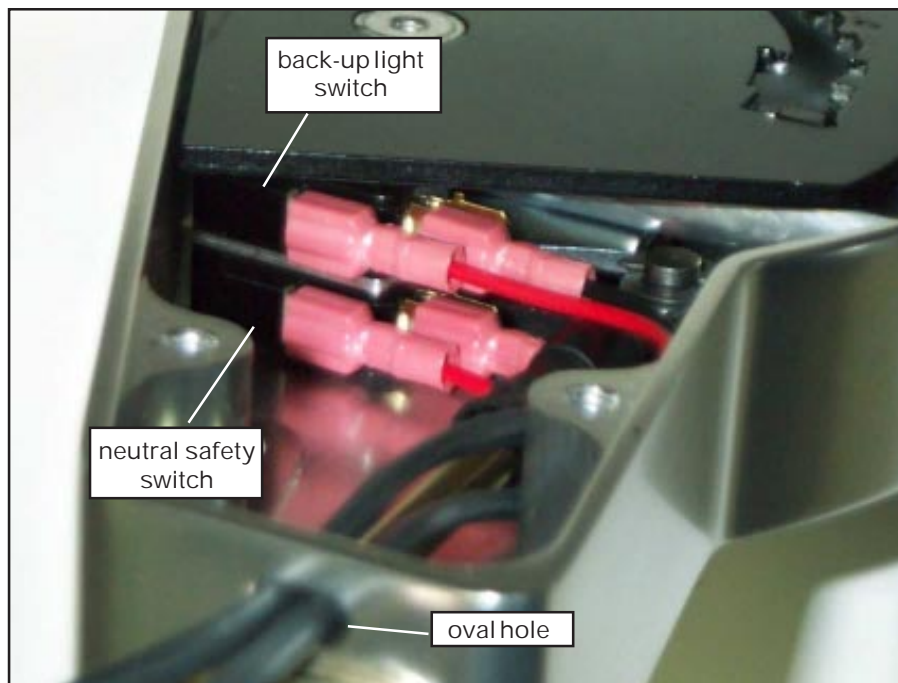

Photo #6

the parking brake. Check the switch operation by attempting to start the motor in each shifter position. The starter must crank only when the shifter is in the Park or the Neutral position. Check the backup light operation when the shifter is shifted to the Reverse position. Adjust the switches if required, please refer to ADJUSTING THE SWITCHES. Reconnect the coil wire. Go to HOW TO OPERATE YOUR B&M STREET BANDIT SHIFTER.

FORD

STEP 18. If you have not already done so, remove the nut and the lockwasher holding the downshift linkage onto the downshift lever shaft from the transmission. The downshift lever is the outer lever on C-4, C-5 and C-6 transmissions. Pull the lever off the shaft and allow the linkage to hang free. Remove and discard the stock shift linkage rods. Some C-6, late C-4 and all C-5 transmissions have a neutral safety/backup light switch on the transmission shift lever. If your transmission is so equipped, remove the two bolts holding the switch in place and slide it off the shift shaft. Disconnect the switch at the factory plug and discard it.

STEP 19. Install B&M's Ford selector lever as shown in Photo #7 & #8 (lever shown in Neutral position) for

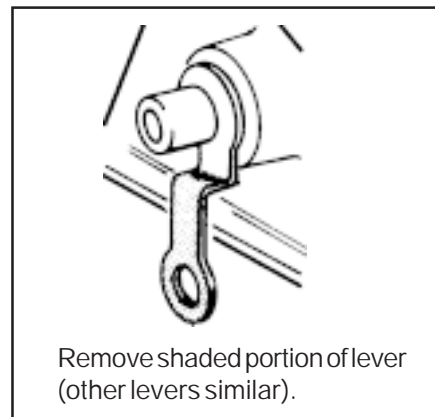

Remove shaded portion of lever (other levers similar).

Figure #5

proper operation. You will have to remove part of the stock arm by cutting it off to clear the B&M lever (See Figure #5). Install B&M's Ford selector lever onto the shift shaft of the transmission. Again align the selector lever as shown in Photo #7 & #8, then tighten the ¼"-20 x 1 ½" pinch bolt and the nut. The lever should travel smoothly from front to back with a positive click in each gear position. Make sure o-ring is in position on the downshift shaft and install the downshift lever in position on the shaft. Install the lockwasher and the nut and tighten securely. The downshift lever must operate smoothly. Reconnect the downshift linkage.

STEP 20. Cable bracket installation: C-4, C-5: Remove the two lower bolts from the rear servo cover. Install the

cable bracket into position (See Photo #7). Install the two servo cover bolts as removed and tighten to 12-13 lb.ft. Do not overtighten as this can distort the servo cover.

C-6: Remove the two transmission oil pan bolts from the left rear corner of the oil pan. Install the cable bracket into position with the two spacers between the pan and the bracket (See Photo #8). (If your transmission is equipped with a cast aluminum oil pan, these spacers are omitted). Install the two supplied 5/16-18 x 1.00" bolts and tighten to 12-13 lb.ft. Do not overtighten as this can damage the pan gasket.

STEP 21. Route the shifter cable avoiding kinks and sharp bends and route the cable away from hot engine or exhaust parts. Remove the two rubber boots, one large nut, and a large lockwasher from the threaded end of the shifter cable. Slide the end of the cable into the cable bracket. Install the large nut and the lockwasher loosely over the end of the cable. Install the two rubber boots onto the end of the cable. Install the swivel on the threaded end of the cable and position it in the center of the threaded portion (See Photo #7 & #8).

STEP 22. Move the transmission selector lever by hand to the full forward position (Low). Place the shifter lever to the Low gear position (all the way back). Adjust the large nuts on the cable so that the swivel will slide into the hole on the selector lever. Tighten the large nuts completely. Be sure that the swivel will slide freely in and out of the hole in the selector lever.

STEP 23. With the swivel in the selector lever, move the shifter to the Park position, as far forward as the shifter will go without forcing it. (The shifter has further travel that is used to reach the GM Park position but is not used on the Ford transmissions. Trying to force the cable will damage the cable). The shift lever on the transmission should be all the way back. Check to see that the swivel will slide freely in and out of the hole in the lever in this position. If it does not slip in freely, adjust the swivel slightly until it will slip into the hole in the lever in both Low and Park positions. Operate the shifter through all

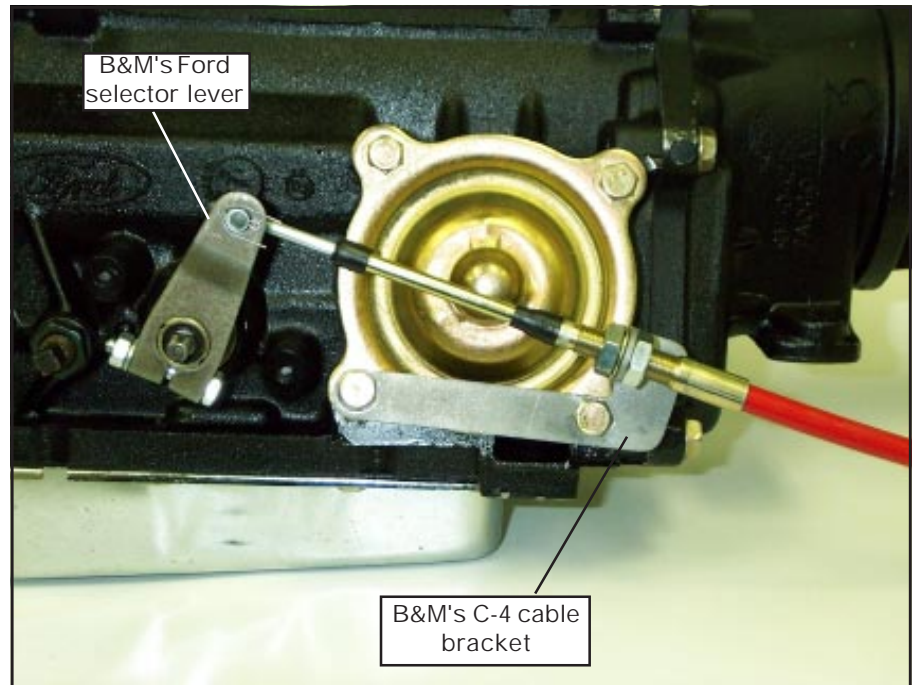

Photo #7

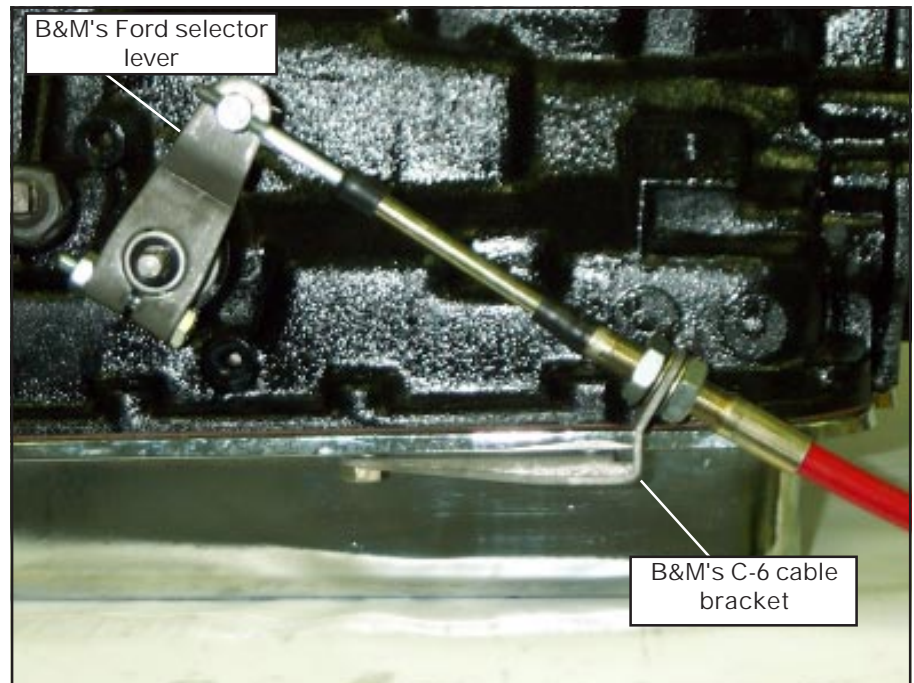

Photo #8

the gear positions. Check to make sure the swivel will slide in and out of the selector lever hole in each gear position. Install the cotter key supplied with the shifter into the swivel and spread the key ends.

If you have a problem, **DO NOT FORCE THE SHIFTER**, this will damage the cable, the shifter or the transmission. Simply start at the beginning and carefully check all your steps.

IMPORTANT: Do not force the shifter

to over travel into the Park position. This will move the shifter into the GM Park position and will damage the cable or transmission.

STEP 24. The oval hole in the rear of the shifter body will serve as the exit for the two switch wires (See Photo #6). Since the neutral safety switch is a breaker that keeps the starter from engaging until the switch is closed in Neutral or Park, the color of the wires is not critical. It is only being used to

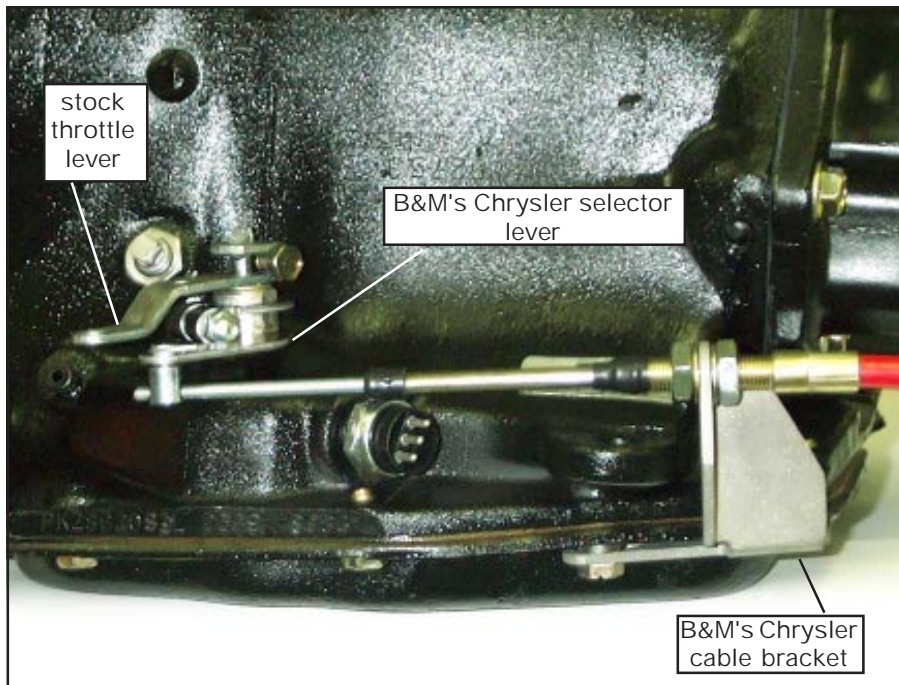

Photo #9

break the 12V wire from the starter switch to the small wire on the starter solenoid. The reverse light switch has the same function only that it breaks the power to the reverse lights. If your wiring is different, follow the instructions that pertain to your specific wiring layout.

STEP 25. On Ford vehicles, the neutral safety/backup light switch is located on the transmission (or on the steering column on some early vehicles). On the C-4 and C-5 transmissions, it is necessary to completely remove the stock neutral safety/backup light switch in order to install the B&M transmission shift lever. On C-4, C-5 and C-6 transmissions, it will be necessary to hook up the neutral safety/backup light switches on the B&M Street Bandit Shifter.

STEP 26. Locate and identify the neutral safety (the engine will not crank unless these wires are connected together) and the reverse light wires. Disconnect the battery ground cable before beginning to wire the neutral safety and the reverse light switches. Reroute the wires to the B&M Street Bandit Shifter. Strip a 1/4" of insulation off the wires and install the supplied slip-on terminals. Crimp the terminals onto the wires using a crimping tool or pliers. Connect the neutral safety wires to the LOWER switch and the

reverse light wires to the UPPER switch (See Photo #6). Tape the terminal connections to prevent shorts.

STEP 27. Reconnect the battery ground cable, disconnect the coil wire and set the parking brake. Check the switch operation by attempting to start the motor in each shifter position. The starter must crank only when the shifter is in the Park or the Neutral position. Check the backup light operation when the shifter is shifted to the Reverse position. Adjust the switches if required, please refer to ADJUSTING THE SWITCHES. Reconnect the coil wire. Go to HOW TO OPERATE YOUR B&M STREET BANDIT SHIFTER.

CHRYSLER

STEP 28. If you have not already done so, loosen the pinch bolt on the throttle lever on the transmission. This is the lever on the small diameter shaft. Pry the lever off with a screwdriver and allow the linkage to hang free. Remove and discard the stock shift lever and the stock shift linkage. Install B&M's Chrysler selector lever in position and tighten the pinch bolt securely (See Photo #9). Make sure the lever is not pushed down so far as to touching the transmission case. This will cause the lever to bind on the case. The lever should travel smoothly from front to

back with a positive click in each gear position. Install the stock throttle lever into position on the small diameter shaft as removed and tighten the pinch bolt securely. The throttle lever must operate smoothly.

STEP 29. Remove the two transmission oil pan bolts from the left rear corner of the transmission pan. Install the cable bracket into position with two spacers between the pan and the bracket (See Photo #9). (If your transmission is equipped with a cast aluminum oil pan these spacers can be omitted). Install the two supplied 5/16-18 x 1.00" pan bolts and tighten to 12-13 lb.ft. Do not overtighten as this can damage the pan gasket.

STEP 30. Route the shifter cable avoiding kinks and sharp bends and route the cable away from hot engine or exhaust parts. Remove the two rubber boots, one large nut, and a large lockwasher from the threaded end of the shifter cable. Slide the end of the cable into the cable bracket. Install the large nut and the lockwasher loosely over the end of the cable. Install the two rubber boots onto end of cable. Install the swivel on the threaded end of the cable and position it in the center of the threaded portion (See Photo #9).

STEP 31. Move the transmission selector lever by hand to the full forward position (Low). Place the shifter lever to the Low gear position (all the way back). Adjust the large nuts on the cable so that the swivel will slide into the hole on the selector lever. Tighten the large nuts completely. Be sure that the swivel will slide freely in and out of the hole in the selector lever.

STEP 32. With the swivel in the selector lever, move the shifter to the Park position, as far forward as the shifter will go without forcing it. (The shifter has further travel that is used to reach the GM Park position but is not used on the Chrysler transmissions. Trying to force the shifter will damage the cable). The shift lever on the transmission should be all the way back. Check to see that the swivel will slide freely in and out of the hole in the lever in this position. If it does not slip in freely, adjust the swivel slightly until it will slip into the hole in the lever in both Low and Park positions. Operate the shifter

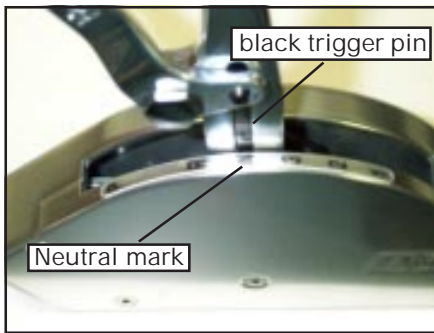

Photo #10

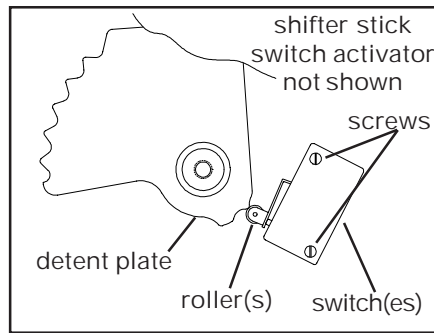

Figure #6

through all the gear positions. Check to make sure the swivel will slide in and out of the selector lever hole in each gear position. Install the cotter key supplied with the shifter into the swivel and spread the key ends.

If you have a problem, **DO NOT FORCE THE SHIFTER**, this will damage the cable, the shifter or the transmission. Simply start at the beginning and carefully check all your steps.

IMPORTANT: Do not force the shifter to over travel into the Park position. This will move the shifter into the GM Park position and will damage the cable or transmission.

STEP 33. Check the operation of the throttle linkage again. The linkage must operate smoothly with no bind. All transmissions using automatic valve bodies must have the throttle linkage connected and operating or transmission damage will result.

STEP 34. The oval hole in the rear of the shifter body will serve as the exit for the switch wires (See Photo #6). Since the reverse light switch only breaks the power to the reverse lights, the color of the wires is not critical. If your wiring is different, follow the instructions that pertain to your specific wiring layout.

STEP 35. Neutral safety/backup light switch;

'66-'68: The neutral safety switch will continue to function normally. It will not be necessary to hook up the neutral safety switch wires on the shifter. Disconnect the battery ground cable before wiring the backup light switch. Locate the original backup light switch on the steering column or the console shifter. Run these wires to the UPPER switch on the B&M Street Bandit Shifter (See Photo #6). Reconnect

the ground wire and check the light for proper operation. Adjust the switch on the shifter if required, please refer to **ADJUSTING THE SWITCHES**.

'69 and Later: The neutral safety/backup switch is located on the transmission and will continue to function normally. It will not be necessary to connect any wires to the switches on the shifter.

HOW TO OPERATE YOUR STREET BANDIT SHIFTER

This example of the B&M Street Bandit Shifter operation is for use with a three speed automatic transmission utilizing a forward pattern valve body only. A four speed gate plate pattern is similar and is included with this kit.

First Gear: (Starting with the shifter in Park). To shift from Park to Low gear, squeeze the trigger to allow the release of Park lock, then pull the stick all the way back to Low.

Second Gear: To shift from Low to Second, just push the stick forward, this gate is accessible without having to squeeze the trigger.

Third Gear: To shift from Second to High gear, squeeze and hold the trigger firmly, then push the stick forward until it stops. Release the trigger and remove the pressure from the stick allowing the spring loaded selector pin to raise to the top of the gate opening.

Neutral: To shift from High gear to Neutral, apply forward pressure to the stick then squeeze the trigger to the next gate.

Reverse: To shift from Neutral to Reverse squeeze the trigger then push the stick forward to the next gate.

Park: To shift from Reverse to Park

squeeze the trigger then push the stick forward until it stops (without forcing it if used on Ford or Chrysler transmissions).

CHANGING THE GATE PLATES

Step 1. Remove the five countersunk screws from the cover of the shifter and remove the cover.

Step 2. Remove the gate plate, without moving any of the internal mechanism, by slightly squeezing on the trigger and pulling the gate plate out.

If for any reason the internal shifter mechanism becomes pulled off or away from the shifter body, make sure to check the spring loaded detent lever at the front of the mechanism. The best way to do this is to move the stick all the way back to the Low gear position. This will clear both switch detents away from the actuators. If they are aligned improperly you can easily break the switches. Apply light pressure to the black shift pattern gate plate while using needle nose pliers to rotate the spring loaded detent lever to the left. You will feel the detent locate itself back into position (See Photo #4).

Step 3. Install the gate plate in the reverse order.

Step 4. Place the shifter in the Neutral position and remove the shift pattern sticker from the cover and clean the glue from the sticker off the cover.

Step 5. Place the new shift pattern sticker into place by aligning the Neutral mark on the sticker to the black trigger pin (See Photo #10).

ADJUSTING THE SWITCHES

See instructions on how to remove the shifter cover and the gate plate. Loosen (do not remove) the screws holding the switches with a small flat screwdriver. Move the switches to where the rollers of the switches roll freely on the detent plate and the shifter stick switch activator, then tighten the screws carefully. Do not overtighten as the switch(es) may crack (See Figure #6).