



Equipped with AEM® Dryflow™ Filter
No Oil Required!

INSTALLATION INSTRUCTIONS

PART NUMBER: 22-547

2003-2006

NISSAN

370Z

V6-3.5L

C.A.R.B. E.O. # D-670

* **NOTE:** Legal in California only for racing vehicles which may never be used upon a highway

PARTS LIST

Description	Qty.	Part Number
Air Filter Assy. 3.25 X 5" Dry Ele.	1	21-2110DK
Heat Shield	1	20-547
Inlet Pipe	1	2-5471
Hose, Adapter 3.25/3.00 X 2.25"	1	5-323
Rubber Edge Trim 7"	1	102452
Mount, Rubber 5/8" X 6mm	1	1228598
Edge Trim, 6"	2	8-4006
Edge Trim, 7"	1	8-4007
Washer, 6mm Soft Mount	2	08160
Nut, M6 Hex Serrated	2	444.460.04
1/2" Bnd. Hose Clamp, 2.90"-3.75"	2	9452
1/2" Bnd. Hose Clamp, 3.15"-4.00"	1	9456

Read and understand these instructions **BEFORE** attempting to install this product. Failure to follow installation instructions and not using the provided hardware may damage the intake tube, throttle body and engine.

1. Preparing Vehicle

- a. Make sure vehicle is parked on level surface.
- b. Set parking brake.
- c. If engine has run in the past two hours, let it cool down.
- d. Disconnect negative battery terminal.
- e. Do not discard stock components after removal of the factory system.

2. Removal of stock system

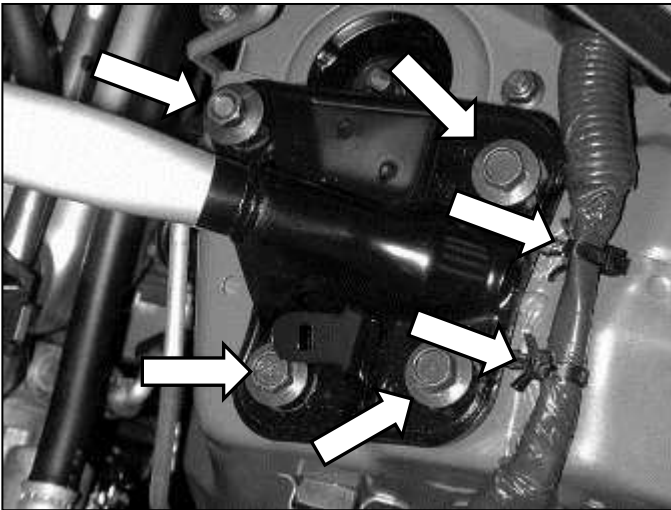

a. Remove the bolts and nut holding the strut tower bar in place. Unclip the electrical wiring loom connections.

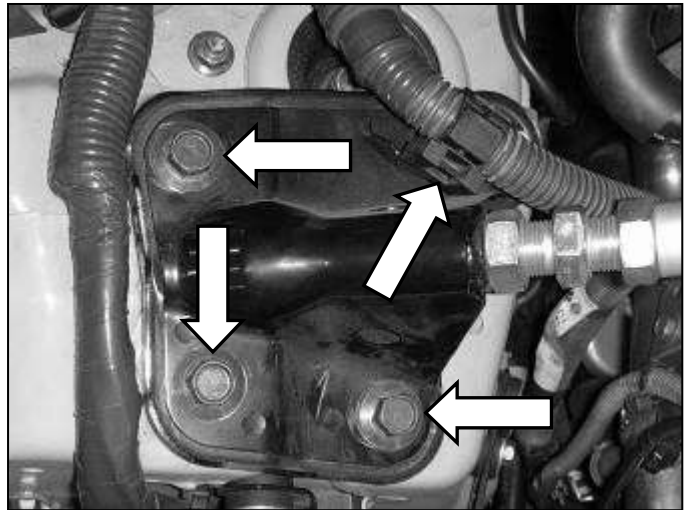

b. Remove the bolts and nut on the passenger side. Remove the remaining bolts to the strut bar. Remove the strut bar.

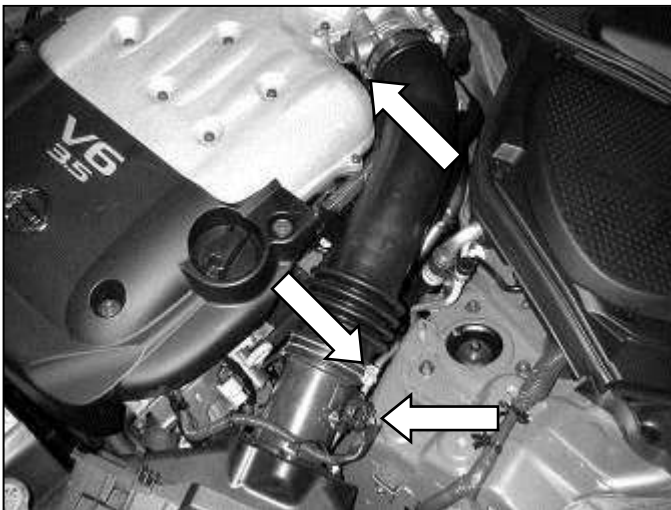

c. Loosen the hose clamps as shown. Unplug the Mass Air Flow (MAF) sensor and detach the MAF wiring harness from the sensor.

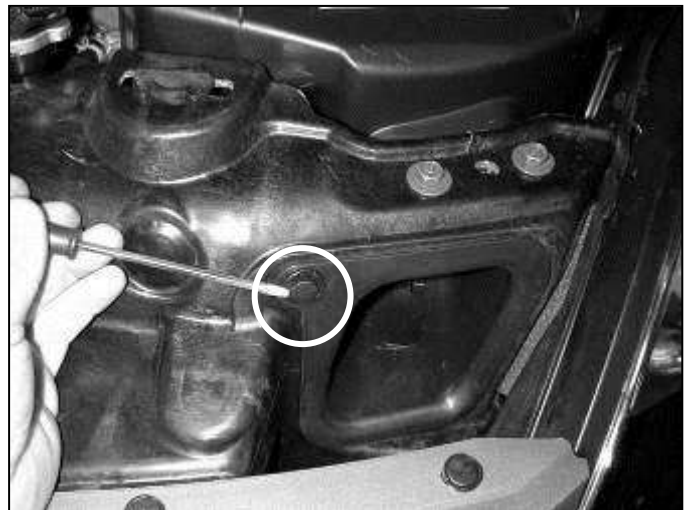

d. Pop out and remove the plastic fastener on the front air duct. Unsnap the duct and slide it forward. Remove the duct from the vehicle.

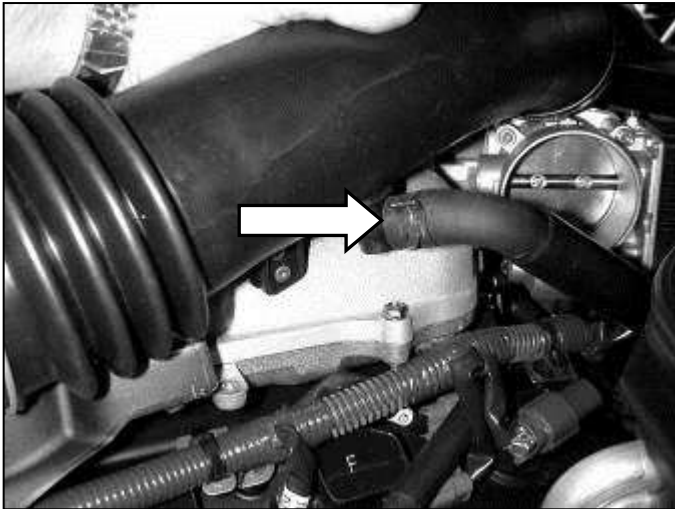

e. From the underside of the intake tube, detach the breather hose then remove the intake tube from the engine bay.



f. Remove the bolt holding the air filter housing assembly in place.



g. Gently pull directly upward on the air filter housing assembly until it unsnaps from its mounts and remove it from the engine bay.

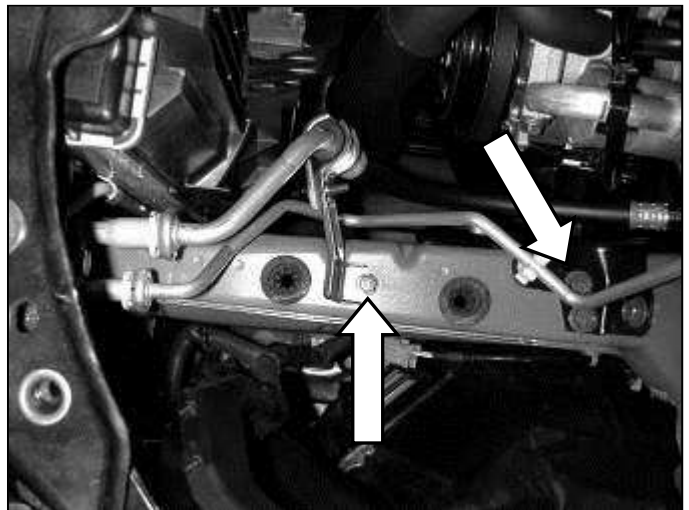

h. Remove the A/C line bracket bolts shown in the picture. The second bolt is located nearest the motor. Be careful not to damage the A/C lines.

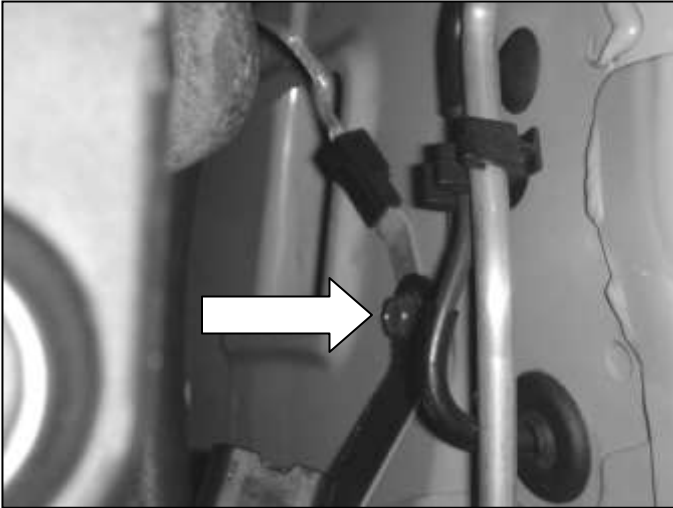

i. Loosen and remove the ground strap bolt. The strap will be reinstalled during the installation process.

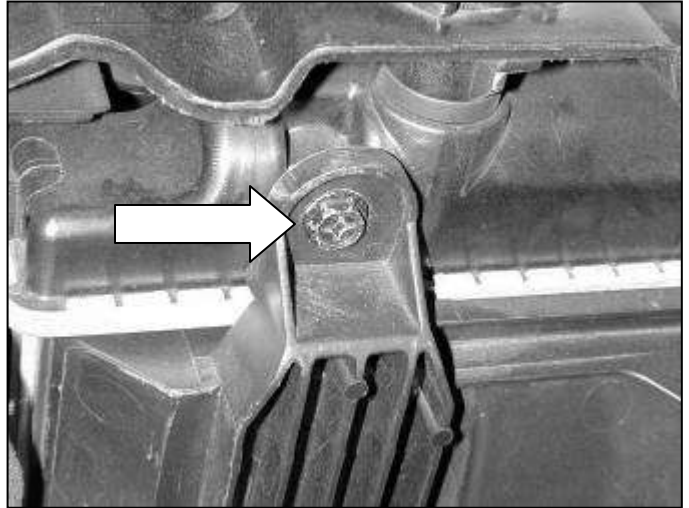

j. Loosen and remove fan shroud mounting screw. This screw will be reused in a later step.

3. Installation of AEM[®] intake system.

a. When installing the intake system, do not completely tighten the hose clamps or mounting hardware until instructed to do so.

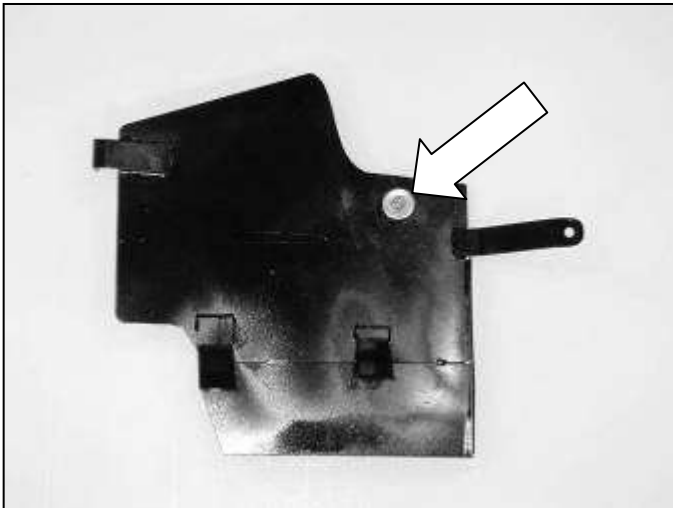

b. Install the rubber mount, washer and serrated nut. The assembly will install on the inside of the heat shield where the mounting brackets are located.

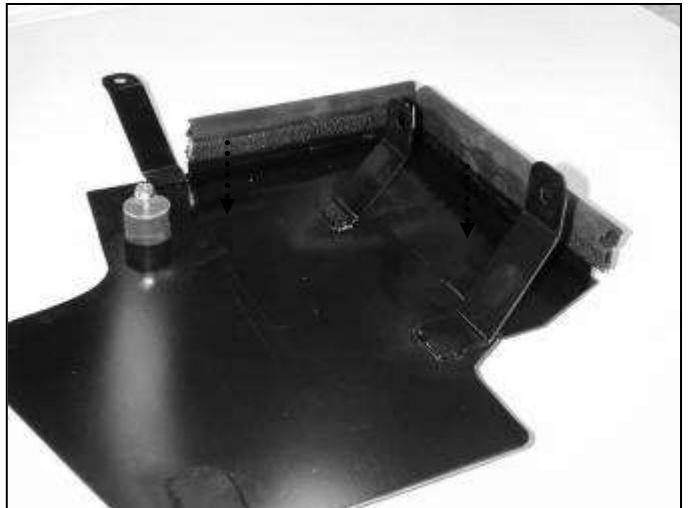

c. Attach the rubber foam gasket to the edges around the mounting brackets.

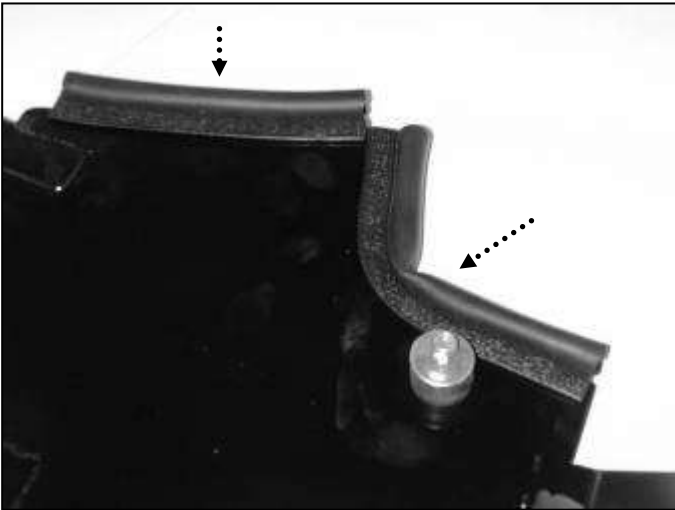

d. Attach the remaining rubber foam gasket to the top of the heat shield.

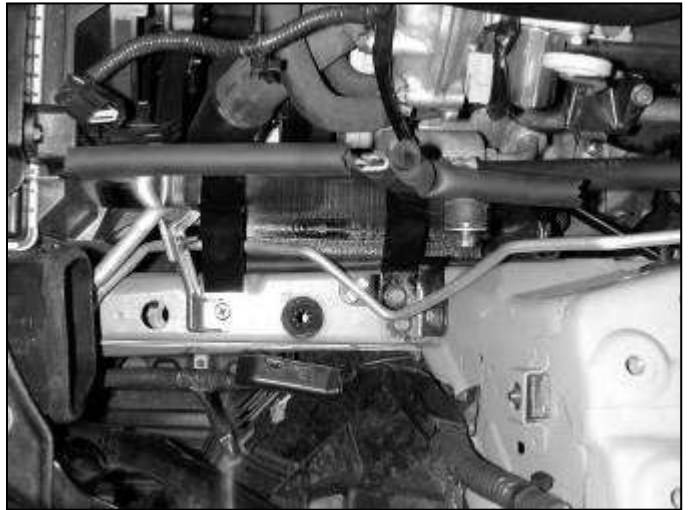

e. Insert the heat shield as shown. Note the rubber mount is on the strut tower side.

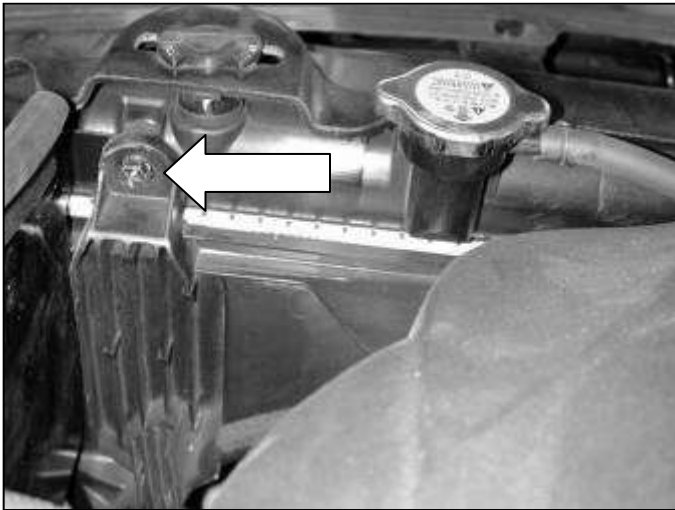

f. Secure the heat shield at the radiator with the factory screw. Be careful not to over tighten.

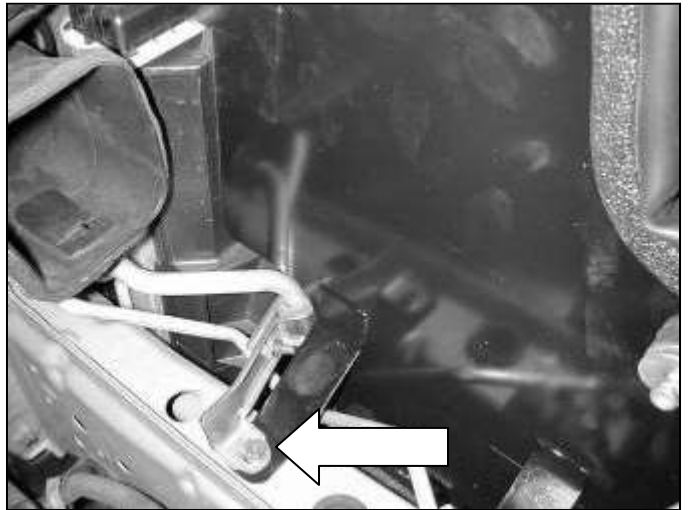

g. Install the A/C bracket bolt. The heat shield bracket installs underneath the A/C bracket.

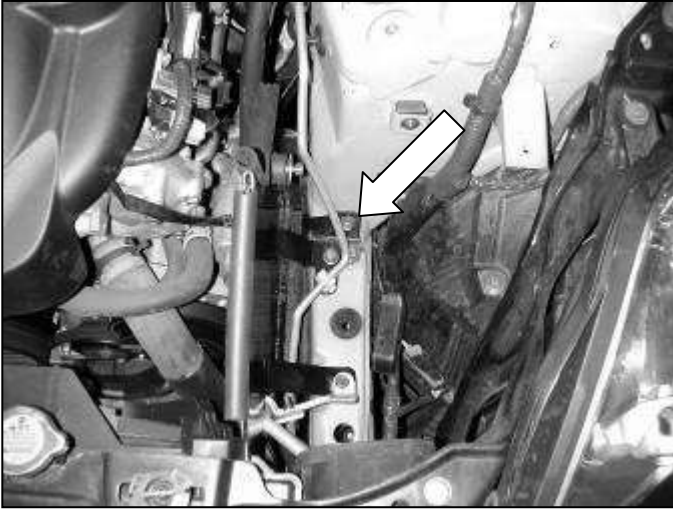

h. Install the other A/C mounting bolt. The heat shield bracket installs on top of the A/C mount.

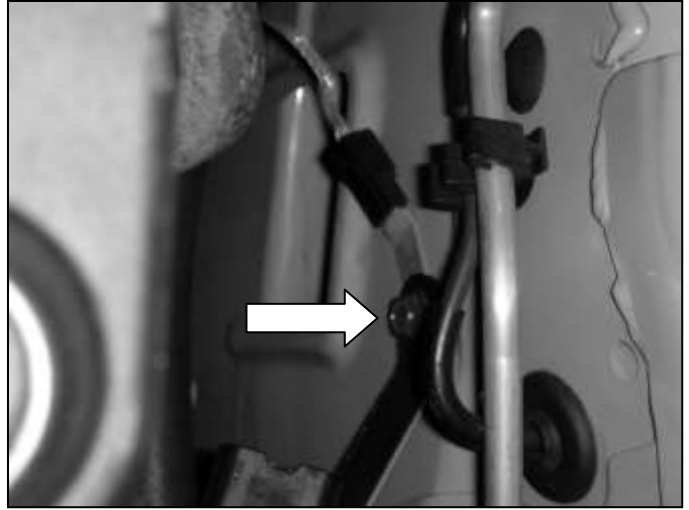

i. Install the ground strap mounting bolt. The heat shield bracket installs on top of the ground strap.



j. Install the coupler onto the throttle body. The 3" side attaches to the throttle body. Tighten the coupler to the throttle body with hose clamp no. 48.

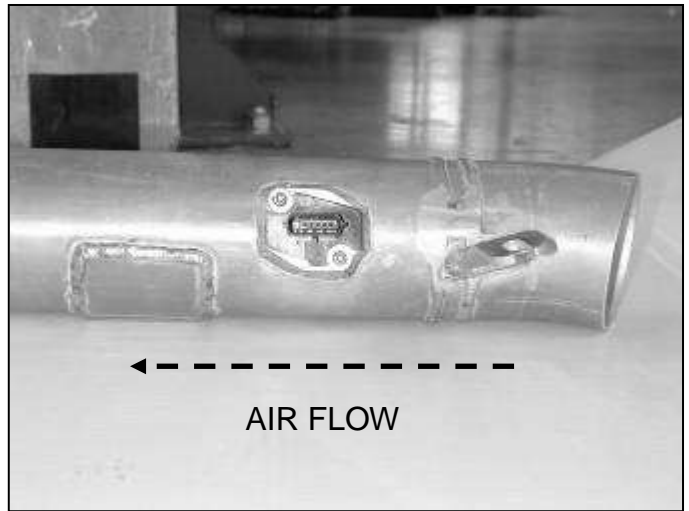

k. Install the MAF sensor into the pipe with factory hardware. Be careful not to damage the sensor during installation. Note the air flow direction.

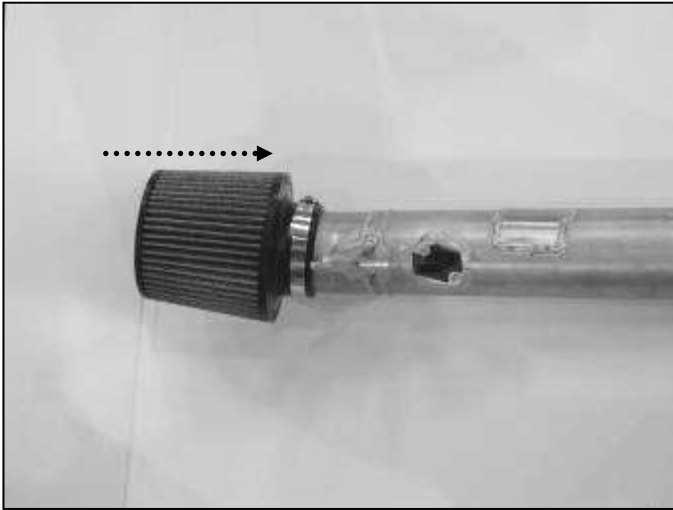

l. Attach the air filter element to the end of the inlet pipe. Secure with hose clamp.



m. Insert the inlet pipe into the coupler. The bracket should be on the opposite side.



n. Reattach the crankcase breather hose to the inlet pipe. Secure with the factory spring clamp.



o. Align the mounting bracket to the rubber mount installed in step 3b. See diagram below for proper assembly.

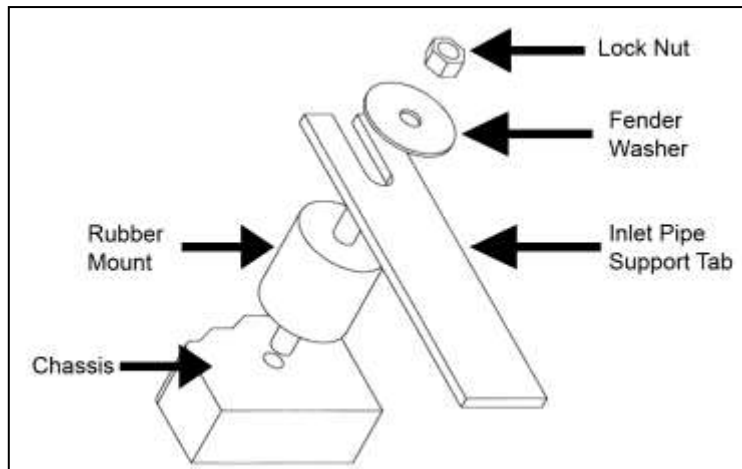

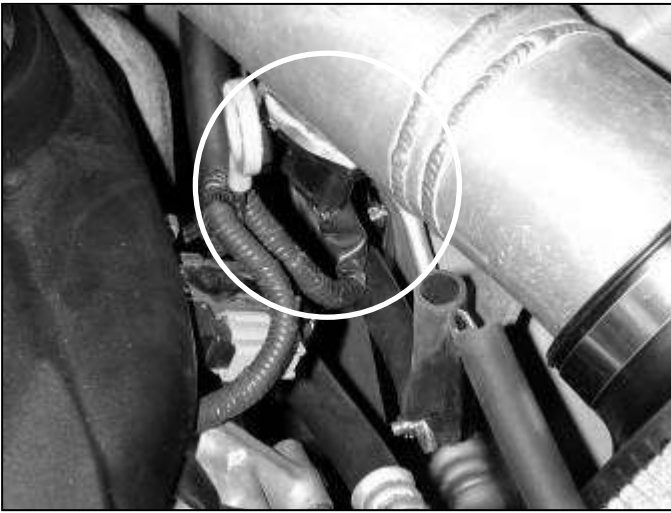

p. Check for clearance around the MAF sensor. Reattach the MAF sensor wire harness, ensure there is adequate clearance.



AEM® intake system installed

4. Reassemble Vehicle

- a. Install the strut tower bar and any hardware removed during steps 2a-2b.
- b. Position the inlet pipes for the best fitment. Be sure that the pipes or any other components do not contact any part of the vehicle. Tighten the rubber mount, all bolts, and hose clamps.
- c. Check for proper hood clearance. Re-adjust pipes if necessary and re-tighten them.
- d. Inspect the engine bay for any loose tools and check that all fasteners that were moved or removed are properly tightened.
- e. Reconnect negative battery terminals and start engine. Let the vehicle idle for 3 minutes. Perform a final inspection before driving the vehicle.

5. CARB Sticker Placement

- a. The C.A.R.B. exemption sticker, (attached), must be visible under the hood so that an emissions inspector can see it when the vehicle is required to be tested for emissions. California requires testing every two years, other states may vary.

6. Service and Maintenance

- a. It is recommended that you service your AEM® Dryflow™ filter every 20,000 miles for optimum performance. Use AEM Dryflow cleaning kit part # 21-110.
- b. Use aluminum polish to clean your polished AEM® intake tube.
- c. Use window cleaner to clean your powder coated AEM® intake tube. **(NOTE: DO NOT USE aluminum polish on powder coated AEM intake tubes).**

For technical inquiries
e-mail us at
sales@aemintakes.com
or
call us at
800.992.3000

AEM Air Intake System Warranty Policy

AEM® warrants that its intake systems will last for the life of your vehicle. AEM will not honor this warranty due to mechanical damage (i.e. improper installation or fitment), damage from misuse, accidents or flying debris. AEM will not warrant its powder coating if the finish has been cleaned with a hydrocarbon-based solvent. The powder coating should only be cleaned with a mild soap and water solution. Proof of purchase of both the vehicle and AEM intake system is required for redemption of a warranty claim.

This warranty is limited to the repair or replacement of the AEM part. In no event shall this warranty exceed the original purchase price of the AEM part nor shall AEM be responsible for special, incidental or consequential damages or cost incurred due to the failure of this product. Warranty claims to AEM must be transportation prepaid and accompanied with dated proof of purchase. This warranty applies only to the original purchaser of product and is nontransferable. Improper use or installation, use for racing, accident, abuse, unauthorized repairs or alterations voids this warranty. AEM disclaims any liability for consequential damages due to breach of any written or implied warranty on all products manufactured by AEM. Warranty returns will only be accepted by AEM when accompanied by a valid Return Merchandise Authorization (RMA) number. Credit for defective products will be issued pending inspection. Product must be received by AEM within 30 days of the date RMA is issued.

If you have a warranty issue, please call (800) 992-3000 and our customer service department will assist you. A proof of purchase is required for all AEM warranty claims.